

RF Connectors

LK Mechanical Lock H Offered as harness







Click on each product information to jump to the web.

Product name		MHF® I LK	MHF® I	MHF® I	MHF® 4L LK	MHF® 4L	MHF® 4L	MHF® 4L	MHF® 4
Appearance		 LK H			 LK H				
		MHF® I with Mechanical lock	Best Insertion Loss	Most Cable O.D. options	MHF® 4L with Mechanical lock	Best Insertion Loss and VSWR	Industry Standard for M.2	Industry Standard for M.2	low profile 1.20 mm
Plug part number		Offered as harness	20767-001R	20278-112R-** 20351-112R-** (O.D.1.37mm)	Offered as harness	20632-001R-37	20565-001R-13	20572-001R-08	20611-001R
Receptacle part number		20279-001E-** (3 pads) / 20441-001E-01 (4 pads)			20449-001E-**(MHF® 4) / 20579-001E(MHF® 4L)				
Maximum height (mm)		2.9	3.0	2.5	2.0	1.7	1.4	1.2	1.2
Outside dimension of receptacle (mm)		3.0 x 3.0			2.0 x 2.0				
Applicable Coaxial Cable O.D. Size [AWG Size]	3.00 mm	-	-	-	-	-	-	-	-
	2.80 mm	-	-	-	-	-	-	-	-
	2.00 mm	-	[AWG 26]	-	-	-	-	-	-
	1.80 mm	[AWG 30]	-	[AWG 30]	-	-	-	-	-
	1.37 mm	[AWG 30]	-	[AWG 30]	[AWG 30]	[AWG 30]	-	-	-
	1.32 mm	[AWG 32]	-	[AWG 32]	-	-	-	-	-
	1.13 mm	[AWG 32]	-	[AWG 32]	-	-	[AWG 32]	-	-
	0.95 mm	-	-	-	-	-	[AWG 33]	-	-
	0.81 mm	[AWG 36]	-	[AWG 36]	-	-	-	[AWG 36]	[AWG 36]
	0.64 mm	-	-	-	-	-	-	[AWG 36]	-
0.48 mm	-	-	-	-	-	-	-	-	
Frequency		DC - 9 GHz			DC – 12 GHz (MHF® 4L Plug x MHF® 4L Rece) , DC – 9 GHz (MHF® 4L Plug x MHF® 4 Rece)				DC - 9 GHz
VSWR (L=100mm)	DC - 3 GHz	1.3 max.(PLUG) / 1.3 max.(RECE)			1.3 max.(Plug) / 1.3 max.(Rece)				
	3 GHz - 6 GHz	1.5 max.(PLUG) / 1.4 max.(RECE)			1.4 max.(Plug) / 1.4 max.(Rece)		1.45 max.(Plug) / 1.4 max.(Rece)		1.5 max. (Plug) / 1.4 max. (MHF 4 Rece)
	6 GHz - 9 GHz	1.6 max.(PLUG) O.D.1.32, 2.0 mm / 1.8 max.(RECE) 1.9 max.(PLUG) O.D.0.81, 1.13, 1.37, 1.80 mm / 1.8 max.(RECE)			1.5 max.(Plug) / 1.55 max.(MHF 4 Rece)		1.6 max.(Plug) / 1.55 max.(MHF 4 Rece) 1.5 max. (MHF 4L Rece)		2.0 max. (Plug) / 1.55 max. (MHF 4 Rece)
	9 GHz - 12 GHz	-			1.6 max.(Plug) / 1.65 max. (MHF 4L Rece)		1.9 max.(MHF 4L Plug) / 1.65 max. (MHF 4L Rece)		-
Service temp. (Celsius)		-40 degree ~ +90 degree							
Characteristic impedance		50ohm							
Rated voltage		AC60V							
Contact resistance		20m ohm max.							
Withstand voltage		AC200V/min							
Insulation resistance		500M ohm min./DC100V							

RF Connectors

ZenShield® Full EMI Shield **LK** Mechanical Lock **H** Offered as harness

Click on each product information to jump to the web.

Product name		MHF® 5L	MHF® 5L	MHF® 5	MHF® 5	MHF® 7S	MHF® -TI
Appearance							
		Improved Insertion Loss and VSWR through 15GHz	Improved Insertion Loss and VSWR through 15GHz	low profile 1.00 mm	low profile 1.00 mm	Unique shielded design increases EMC performance	Robust SMT connector for automotive telematics antenna
Plug part number		20668-001R-13	20714-001R-81	20711-001R-81	20615-002R-48	20980-001R-13	20859-001R-01
Receptacle part number		20566-001E-01				20981-001E-02	20860-001E-01
Maximum height (mm)		1.3		1.0		1.4	3.65
Outside dimension of receptacle (mm)		2.0 x 2.0					9.4 x 5.18
Applicable Coaxial Cable O.D. Size [AWG Size]	3.00 mm	-	-	-	-	-	[AWG 25]
	2.80 mm	-	-	-	-	-	[AWG 26]
	2.00 mm	-	-	-	-	-	-
	1.80 mm	-	-	-	-	-	-
	1.37 mm	-	-	-	-	-	-
	1.32 mm	-	-	-	-	-	-
	1.13 mm	[AWG 32]	-	-	-	[AWG 32]	-
	0.95 mm	-	-	-	-	-	-
	0.81 mm	-	[AWG 33]	[AWG 36]	-	-	-
	0.64 mm	-	-	[AWG 36]	-	-	-
0.48 mm	-	-	-	[AWG 38]	-	-	
Frequency		DC - 15GHz		DC - 12GHz		DC - 15GHz	DC - 6GHz
VSWR (L=100mm)	DC - 3GHz	1.3 max. (Plug/Rece)				1.3 max. (Plug/Rece)	1.5 max. (Plug/Rece)
	3GHz - 6GHz	1.4 max.(Plug/Rece)		1.5 max.(Plug) / 1.4 max. (Rece)		1.35 max. (Plug/Rece)	1.5 max. (Plug/Rece)
	6GHz - 9GHz	1.5 max.(Plug/Rece)		1.6 max.(Plug) / 1.5 max. (Rece)		1.4 max. (Plug/Rece)	-
	9GHz - 12GHz	1.5 max.(Plug/Rece)		1.8 max. (Plug) O.D.0.64 mm, 1.7 max. (Plug) O.D.0.81 mm / 1.65 max. (Rece)	1.6 max. (Plug) / 1.65 max. (Rece)	1.45 max. (Plug/Rece)	-
	12GHz - 15GHz	1.6 max.(Plug) / 1.65 max.(Rece)		-		1.5 max. (Plug/Rece)	-
Service temp. (Celsius)		-40 degree ~ +90 degree					-40 degree ~ +105 degree
Characteristic impedance		50ohm					
Rated voltage		AC60V					
Contact resistance		20m ohm max.					
Withstand voltage		AC200V/min					
Insulation resistance		500M ohm min./DC100V					
Automotive Standards		-					USCAR-2 (*)



Note : (*) Rev.6 - 5.4.6 (Vibration), 5.6.1 (Thermal Shock), 5.6.2 (Temp. & Humidity Cycle), High Temp. Exposure & Life (5.6.3) evaluation passed

RF Connectors : Footprint pattern







Product Name	MHF® I LK	MHF® I		MHF® 4L LK	MHF® 4L			MHF® 4	MHF® 5L	MHF® 5	MHF® 7S	MHF® -TI
Appearance												
Mating Height (Max.)	2.9 mm	3.0 mm	2.5 mm	2.0 mm	1.7 mm	1.4 mm	1.2 mm	1.2 mm	1.3 mm	1.0 mm	1.4 mm	3.65 mm
Footprint pattern (Reference)	<p>3 pads 4 pads</p> <p>MHF® I Rece.</p>			<p>MHF® 4/4L Rece.</p>			<p>MHF® 5/5L Rece.</p>		<p>MHF® 7S Rece.</p>	<p>MHF® -TI Rece.</p>		

RF Accessories : SMA Adapters







SMA Adapters for MHF® Plugs

Type	For electrical performance check		For voltage check
Appearance (Reference)			
Durability (cycles)	3,000		10,000
MHF® I, I LK Plug	90193-001	-	90194-001
MHF® 4, 4L, 4L LK Plug	-	90449-001	90449-003-01
MHF® 5, 5L Plug	90543-0001	-	90586-0001
MHF® 7S Plug	91255-0001	-	91245-0001

SMA Adapters for MHF® Receptacles

Type	For electrical performance check	High cycle series				
		Normal	Narrow pitch		Detachable	
		Probe	Adaptor cable (Attach to probe)	Probe	Adaptor base (Attach to probe)	Probe
Appearance (Reference)						
Durability (cycles)	500	10,000	100	10,000	200,000	10,000
MHF® I Receptacle	90193-002	90539-001	90577-0100 (Cable: 100 mm)	90575-0001	90684-0001	90416-001
MHF® 4, 4L Receptacle	90449-002	90698-0001		90576-0001		90683-0001
MHF® 5 Receptacle	90543-0002	90793-0001		90847-0001		90690-0001
MHF® 7S Receptacle	91256-0001	-	91197-0300	91145-0001	-	-

RF Accessories : Hand Tool

Type	Insertion/ extraction tool	Extraction tool	Insertion tool	Insertion/ extraction tweezer	Extraction tweezer		Insertion/ extraction tweezer		Extraction tool
Appearance (Reference)									
MHF [®] I Plug	90224-001 90885-0001 (*)	90192-001	-	-	-	-	-	-	-
MHF [®] I LK Plug	-	-	-	-	91026-0001	91492-0001	-	-	-
MHF [®] 4 Plug	90435-001	-	-	90482-001	-	-	-	-	-
MHF [®] 4L Plug	90609-0001 (**) 90873-0001 (***)	-	-	90616-0008 90615-0013	-	-	-	-	-
MHF [®] 4L LK Plug	-	-	-	-	-	-	91166-0001	91493-0001	-
MHF [®] 5 Plug	90612-0001	-	90624-0001	-	-	-	-	-	-
MHF [®] 7S Plug	91186-0001	-	-	-	-	-	-	-	-
MHF [®] -TI Plug	-	-	-	-	-	-	-	-	91097-0001

Note
 (*): 90885-0001 is for 20767-001R
 (**): 90609-0001 is for 20572-001R-08 and 20565-001R-13
 (***): 90873-0001 is for 20632-001R-37

MHF[®] Series

Mechanical lock

MHF[®] I LK / MHF[®] 4L LK : Ideal for continuous shock and vibration applications

Locking / Un-Locking Process

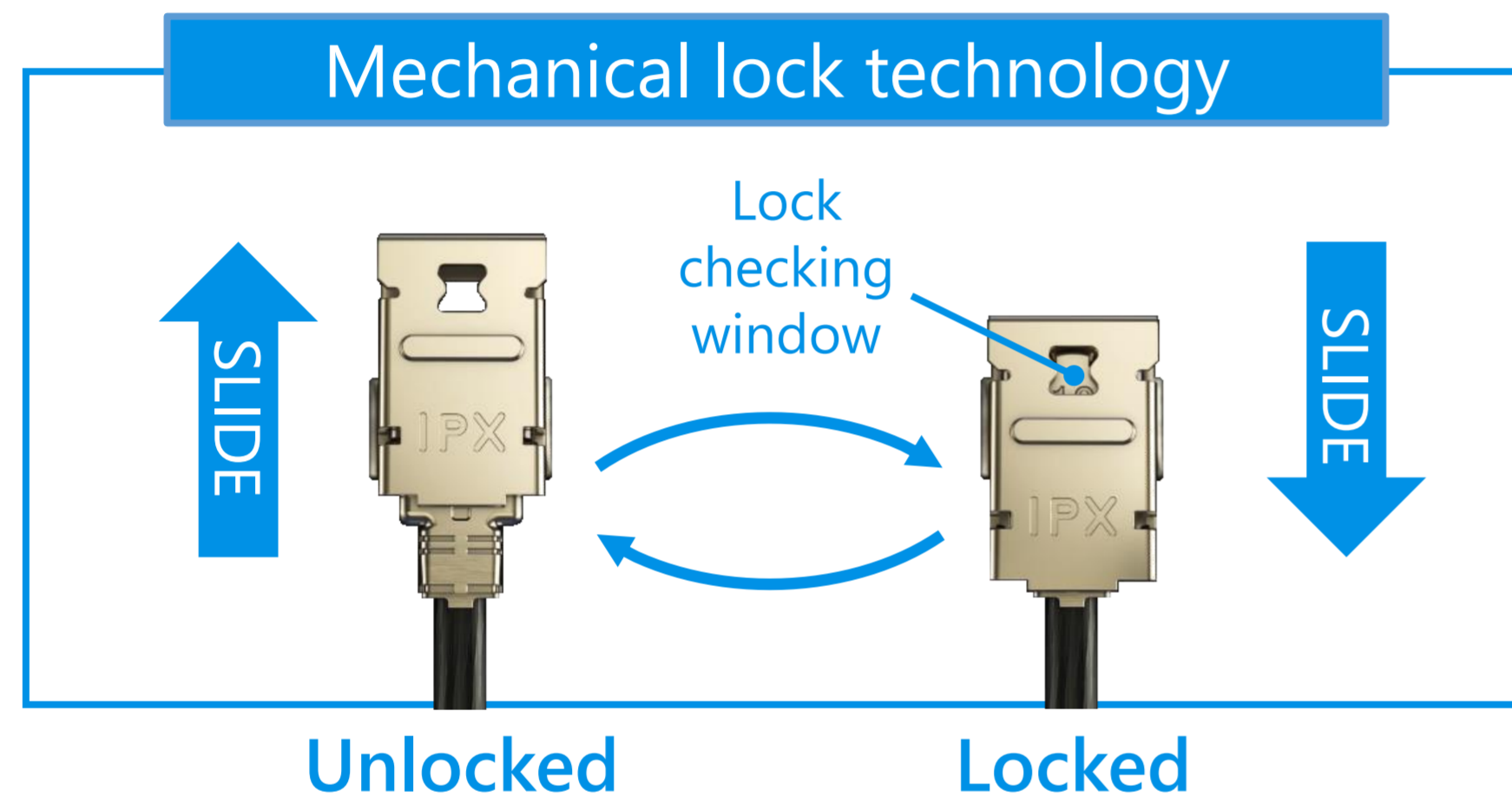

Play full [MHF[®] I LK](#) video

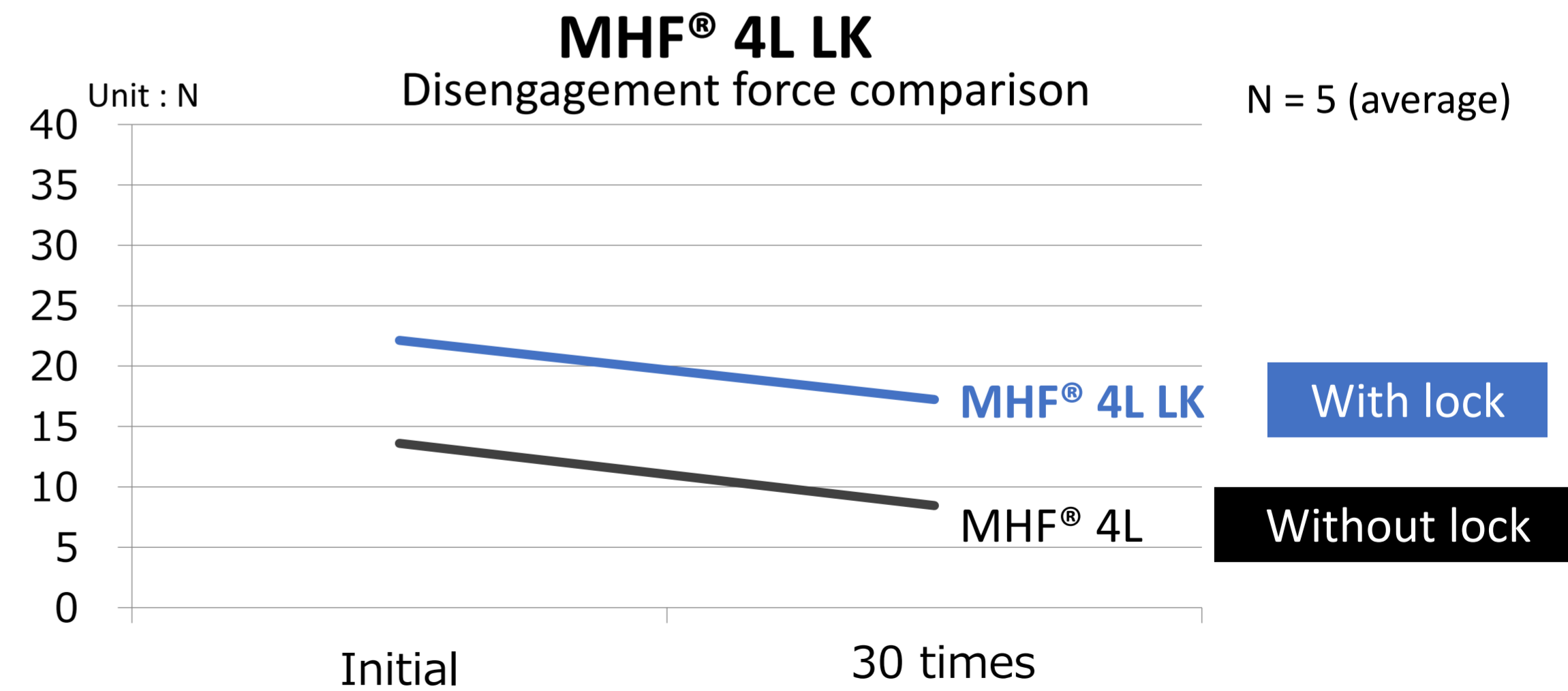
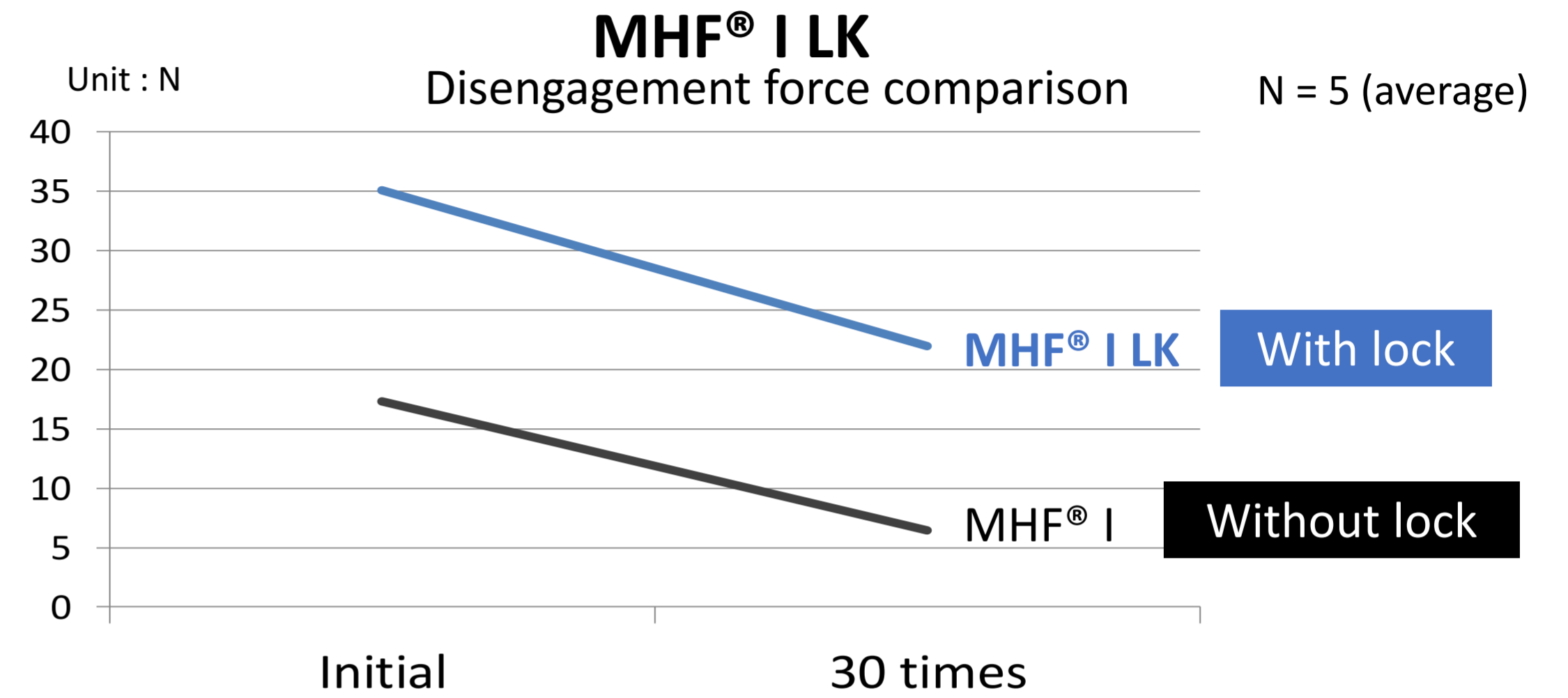

MHF[®] I LK / MHF[®] 4L LK : Component placement prohibited area



MHF I Receptacle mated with MHF[®] I LK harness

MULTIPLE CONNECTORS LAYOUT

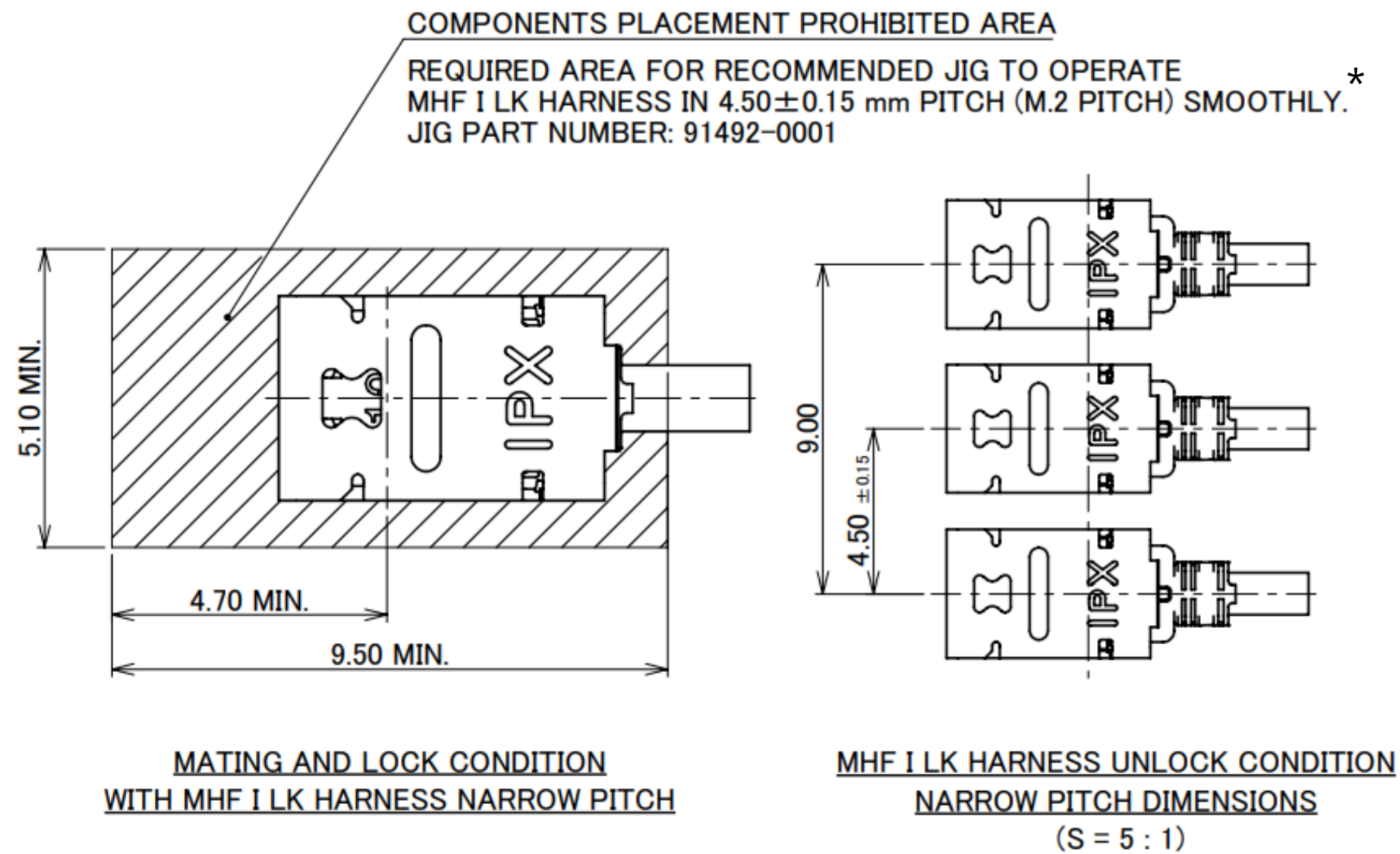

MHF 4L Receptacle mated with MHF[®] 4L LK harness

MULTIPLE CONNECTORS LAYOUT

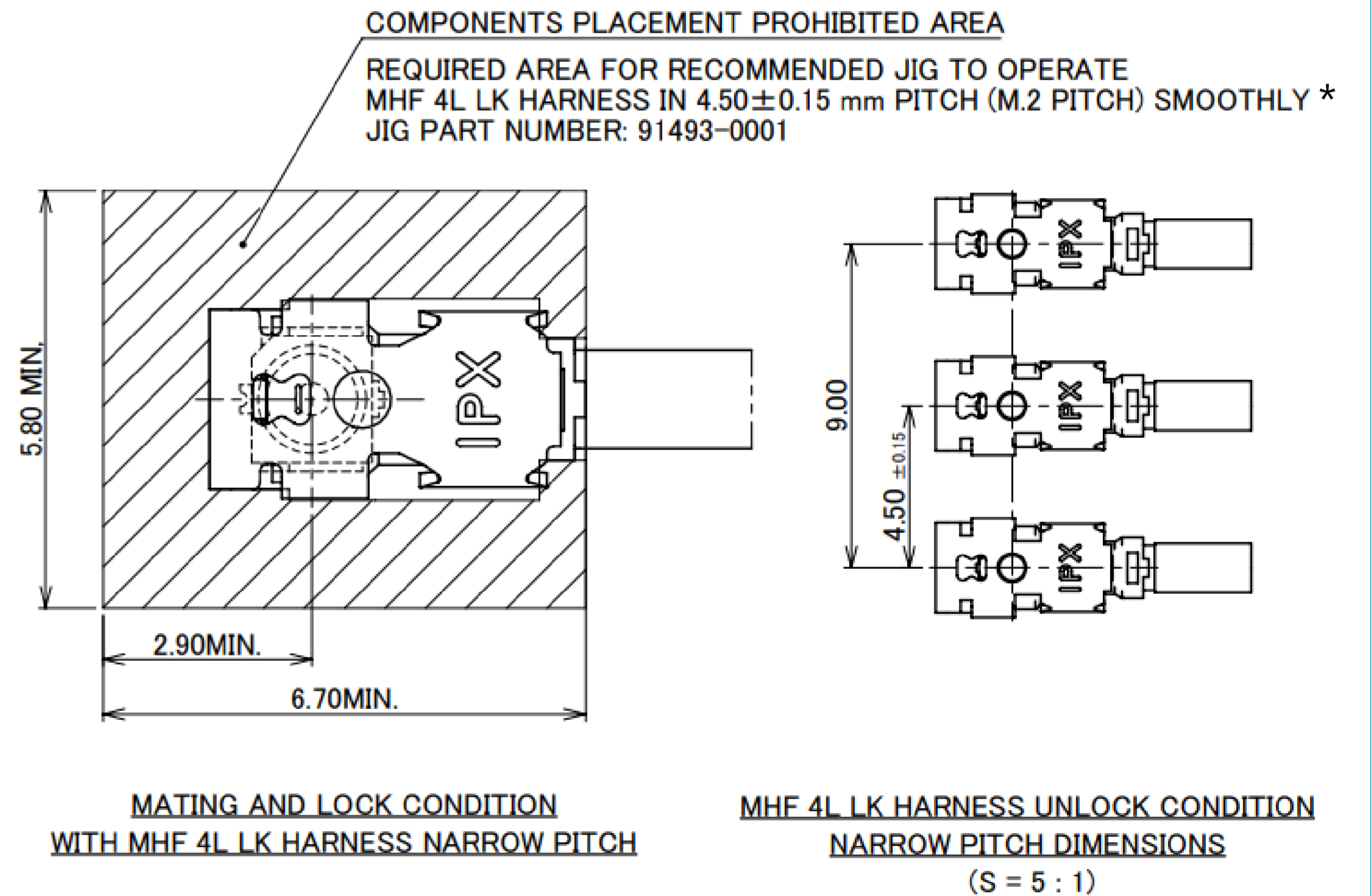



*4.5 mm pitch is M.2 standard compatible. The clearance for the connector layout is not M.2 standard compatible.

MHF[®]-TI : Small, robust RF connector for automotive

Click on the product information to jump to the web. 

 Offered as harness

Product name		MHF [®] -TI
Appearance		
	Robust SMT connector for automotive telematics antenna 	
Plug part number	20859-001R-01	
Receptacle part number	20860-001E-01	
Maximum height (mm)	3.65	
Outside dimension of receptacle (mm)	9.4 x 5.18	
Coax O.D. (Center Conductor AWG)	3.00 mm (25)	
	2.80 mm (26)	
Frequency	DC - 6GHz	
VSWR (L=100mm)	DC – 6GHz	1.5 max.
Service temp. (Celsius)	-40 degree ~ +105 degree	
Characteristic impedance	50ohm	
Rated voltage	AC60V	
Contact resistance	20 m ohm max.	
Withstand voltage	AC200V/min	
Insulation resistance	500M ohm min./DC100V	
Automotive Standards	USCAR-2 (*)	

Note : (*) Rev.6 - 5.4.6 (Vibration), 5.6.1 (Thermal Shock), 5.6.2 (Temp. & Humidity Cycle), High Temp. Exposure & Life (5.6.3) evaluation passed

■ High retention force (90N minimum)

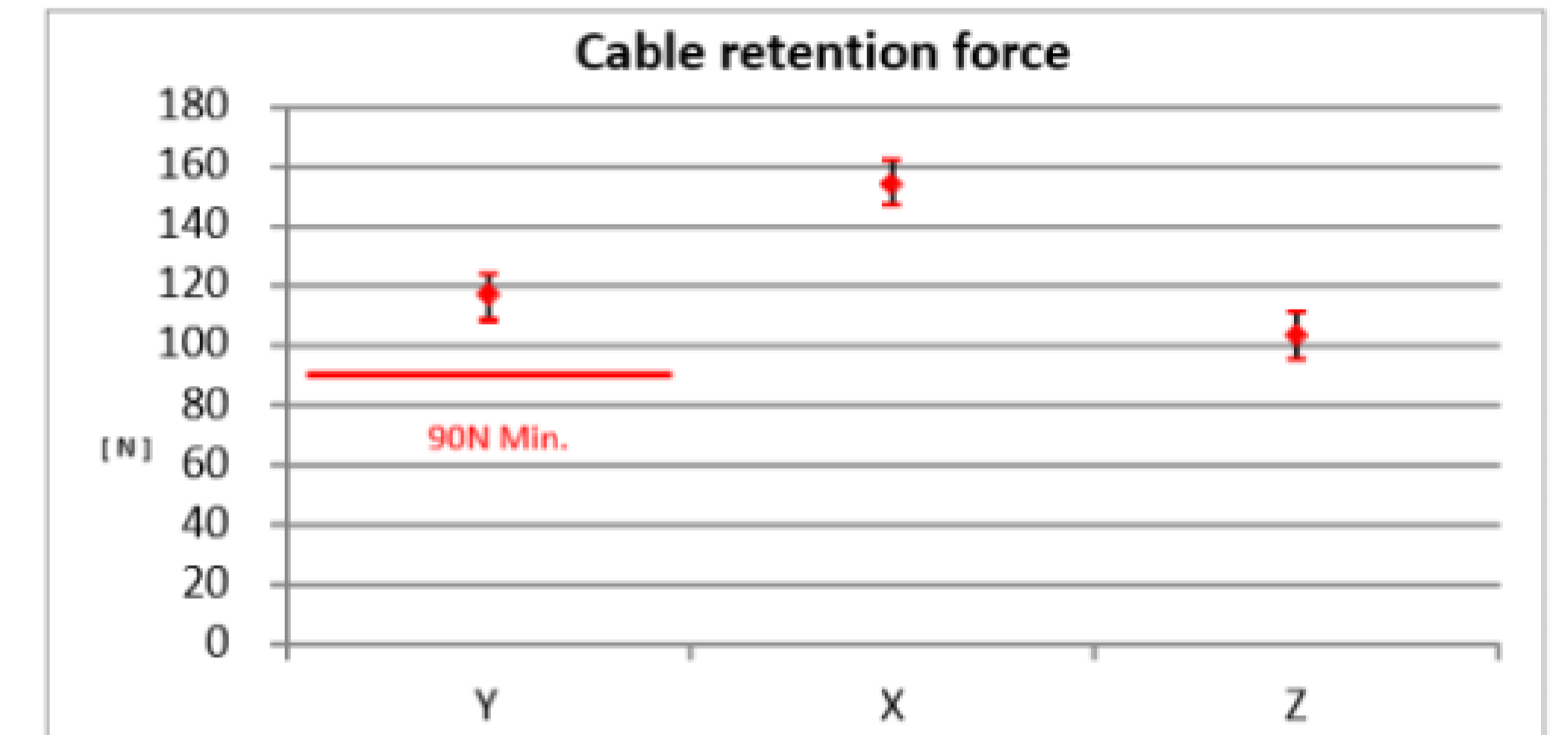
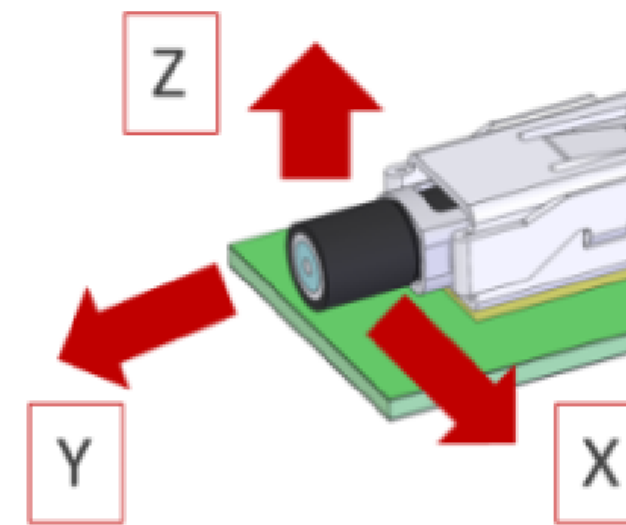

■ Permanent mechanical lock with tactile indication of secure contact

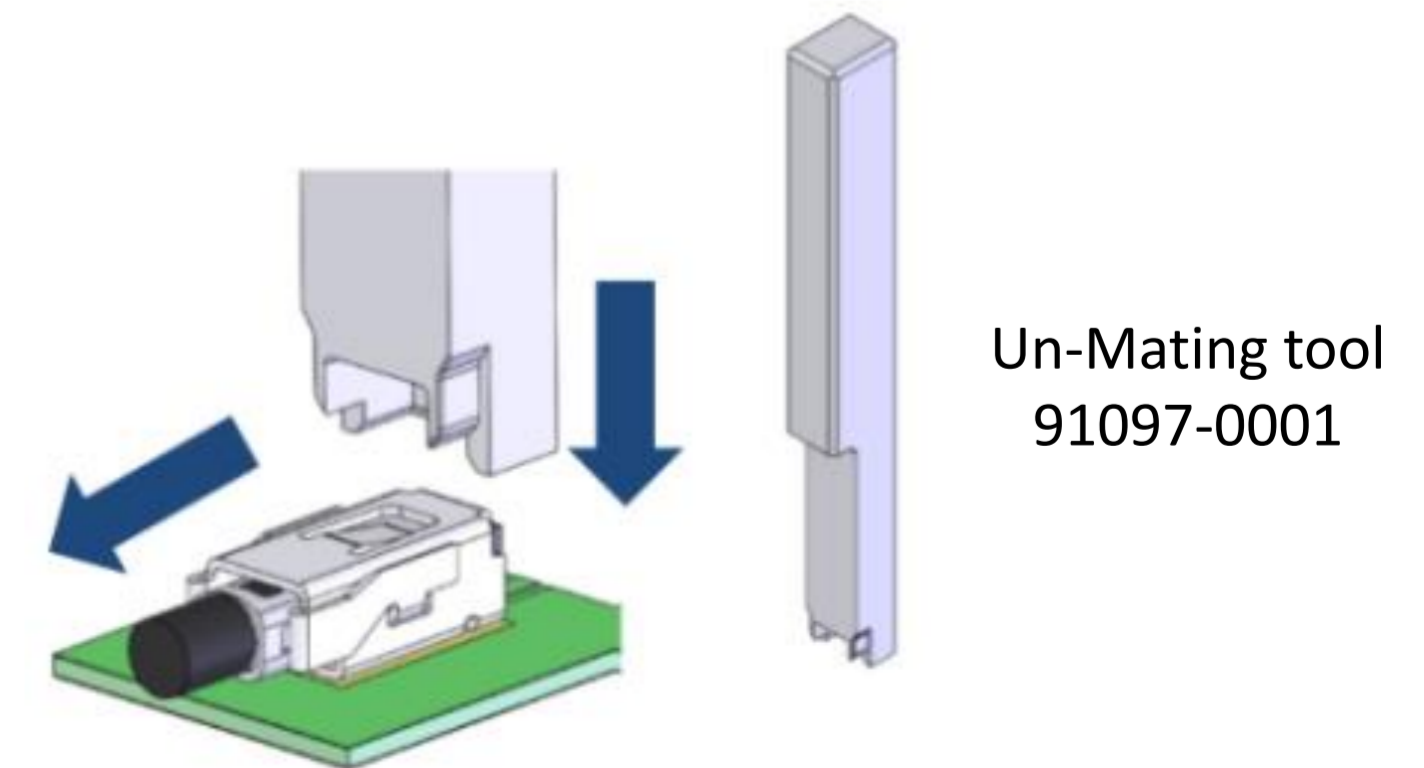
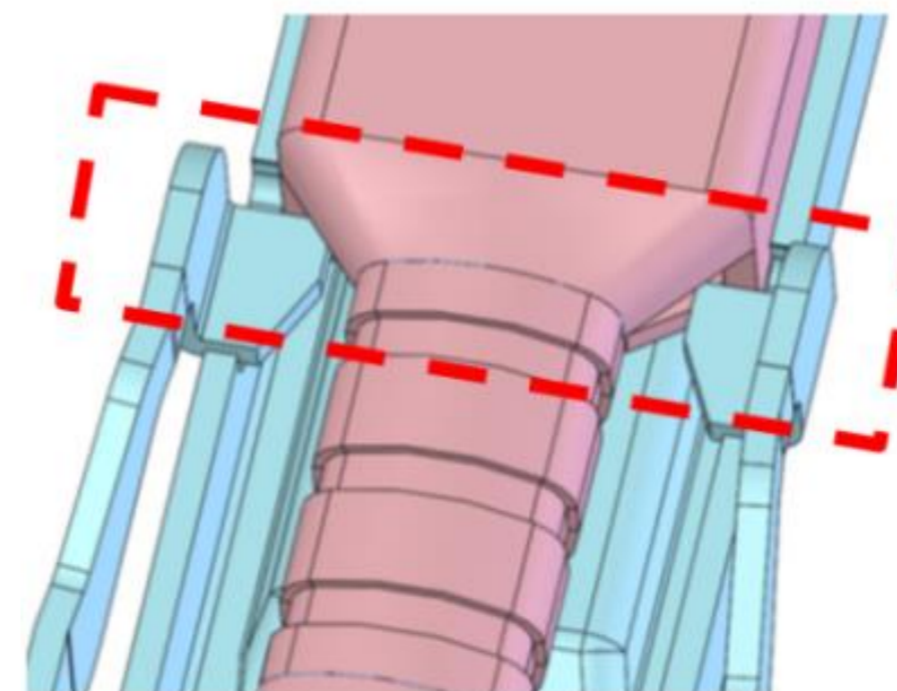

MHF[®]-SW Series



RF Switch

RF Switch: MHF[®]-SW23 & Accessories

Click on the product information to jump to the web. 

Product name		MHF [®] -SW23
Feature		
		Contaminant discontinuity resistant design 2.3 x 2.3 mm footprint
Part number		20549-001E/-01
Dimension (mm)		2.3 x 2.3 x 1.35 (H)
Rated power		2W max.
Frequency		DC - 11.0GHz
V.S.W.R.	DC - 3.0GHz	1.2 max. (DC - 2.5GHz)
	3.0GHz - 6.0GHz	1.3 max. (2.5 - 6.0GHz)
	6.0GHz - 11.0GHz	1.5 max.
Insertion loss	DC - 3.0GHz	0.15 dB max. (DC - 2.5GHz)
	3.0GHz - 6.0GHz	0.20 dB max. (2.5 - 6.0GHz)
	6.0GHz - 11.0GHz	0.40 dB max.
Isolation	DC - 3.0GHz	20 dB Max. (DC - 2.5GHz)
	3.0GHz - 6.0GHz	15 dB max.
	6.0GHz - 11.0GHz	12 dB max.
Service temp. (Celsius)		-40 degree ~ +85 degree
Characteristic impedance		50 ohm
Contact resistance	Signal contact	100m ohm
	Ground contact	100m ohm
Insulation resistance		DC100 1000M ohm min :Initial 10M ohm min :After test
Withstand voltage		AC 100V: 1min

SMA Adapters for MHF[®] Switch

Type	Cable probe	High cycle series	
	Friction lock	Normal probe	Floating probe
Appearance (Reference)			
Durability (cycles)	1,000	10,000	200,000
MHF [®] -SW23	90582-0300 (Cable: 300 mm) 90582-0400 (Cable: 400 mm)	90604-0001	90605-0001

On State

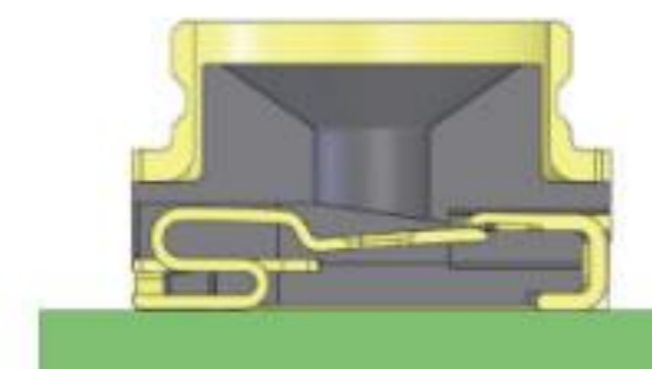

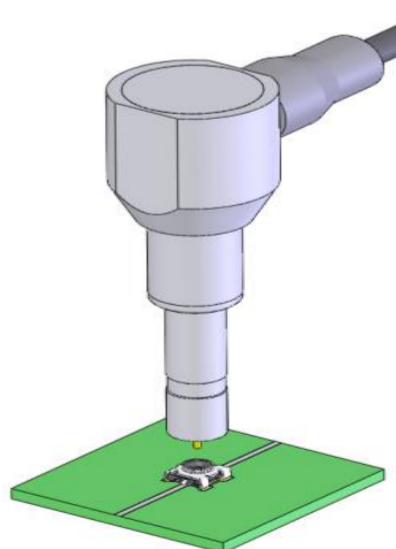
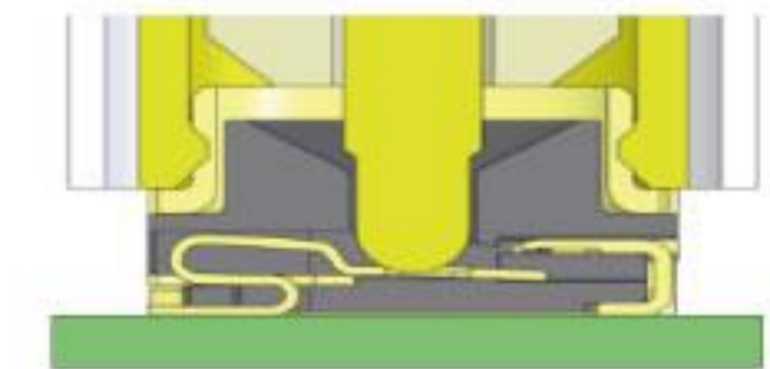

Off State



RF Connector for RF switch : MHF[®]-SW23 plug

Click on the product information to jump to the web. 

 Offered as harness

Product name		MHF [®] -SW23 Plug
Appearance		 
		Mating with switch connector
Plug part number		20851-001R
Switch connector part number		20549-001E/-01 (MHF [®] -SW23)
Maximum height (mm)		3.7
Outside dimension of switch connector		2.3 x 2.3
Coax O.D. (Center Conductor AWG)		1.13 mm (32)
Frequency		DC - 9GHz
VSWR (L=100mm)	0.3 - 3GHz	1.4 max.
	3GHz - 6GHz	1.6 max.
	6GHz - 9GHz	2.0 max.
Rated power		2W max.
Service temp. (Celsius)		-40 degree ~ +85 degree
Characteristic impedance		50ohm
Contact resistance	Signal contact	100m ohm max.
	Ground contact	100m ohm max.
Insulation resistance		DC100 1000M ohm min :Initial 10M ohm min :After test
Withstand voltage		AC200V/min

Flexibility to choose on-board antenna or external antenna

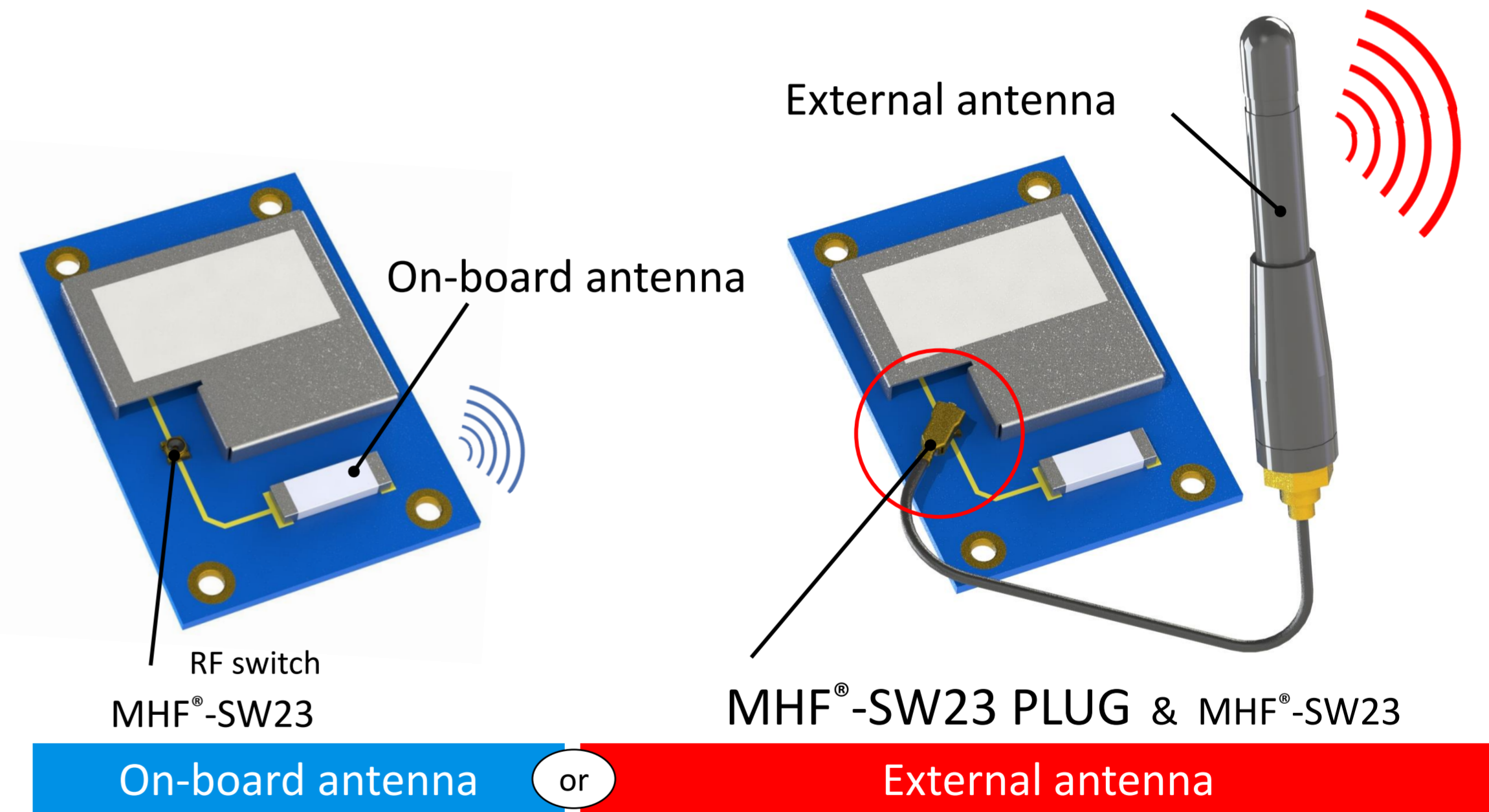

MHF[®] Harnesses

i-Fit[®] Technology: Solderless Wire Crimp Terminating Technology

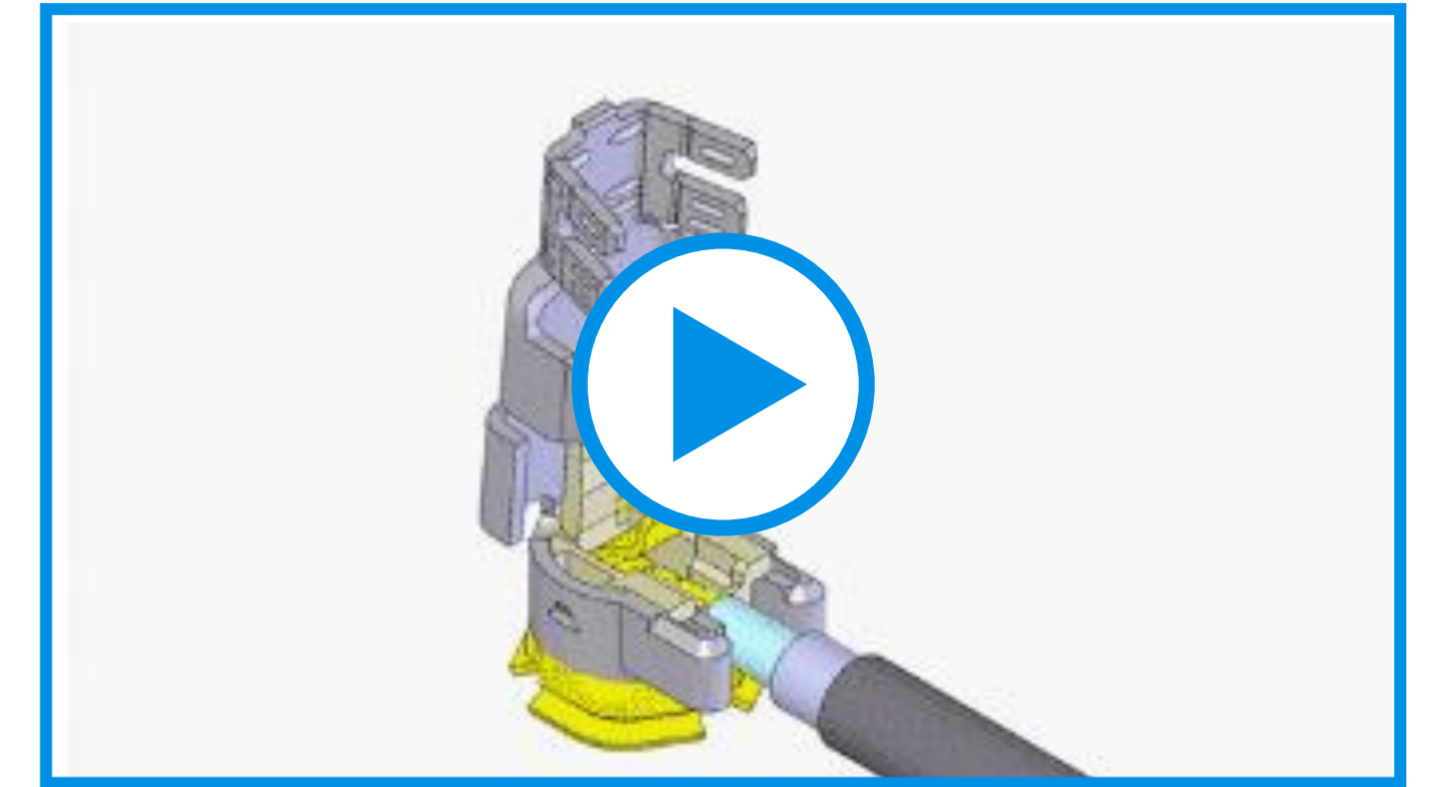
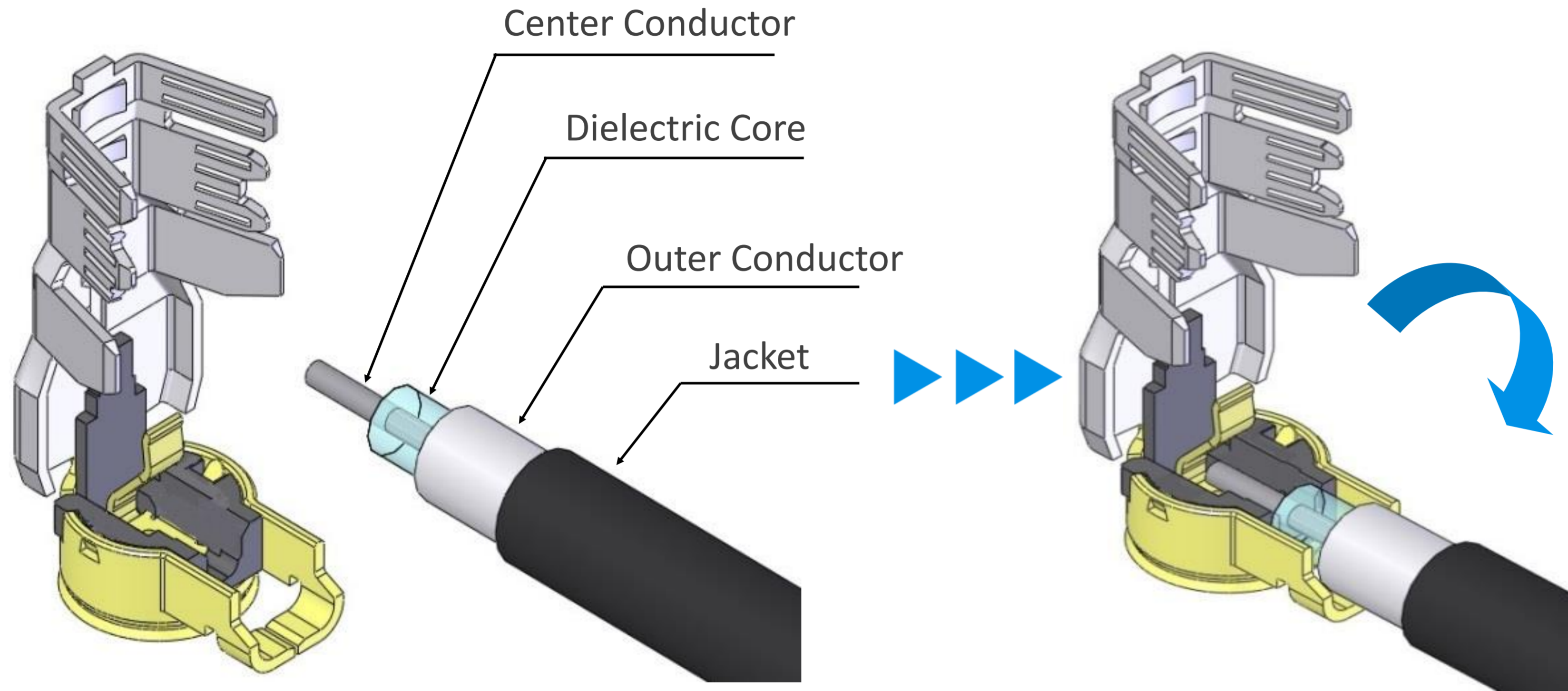

Play full [i-Fit[®] technology](#) video

I-PEX's [i-Fit[®] solderless terminating technology](#) is the core of the MHF[®] connector series. Simple and scalable, i-Fit[®] enables MHF[®] harnesses to have consistent performance values within a tight range.

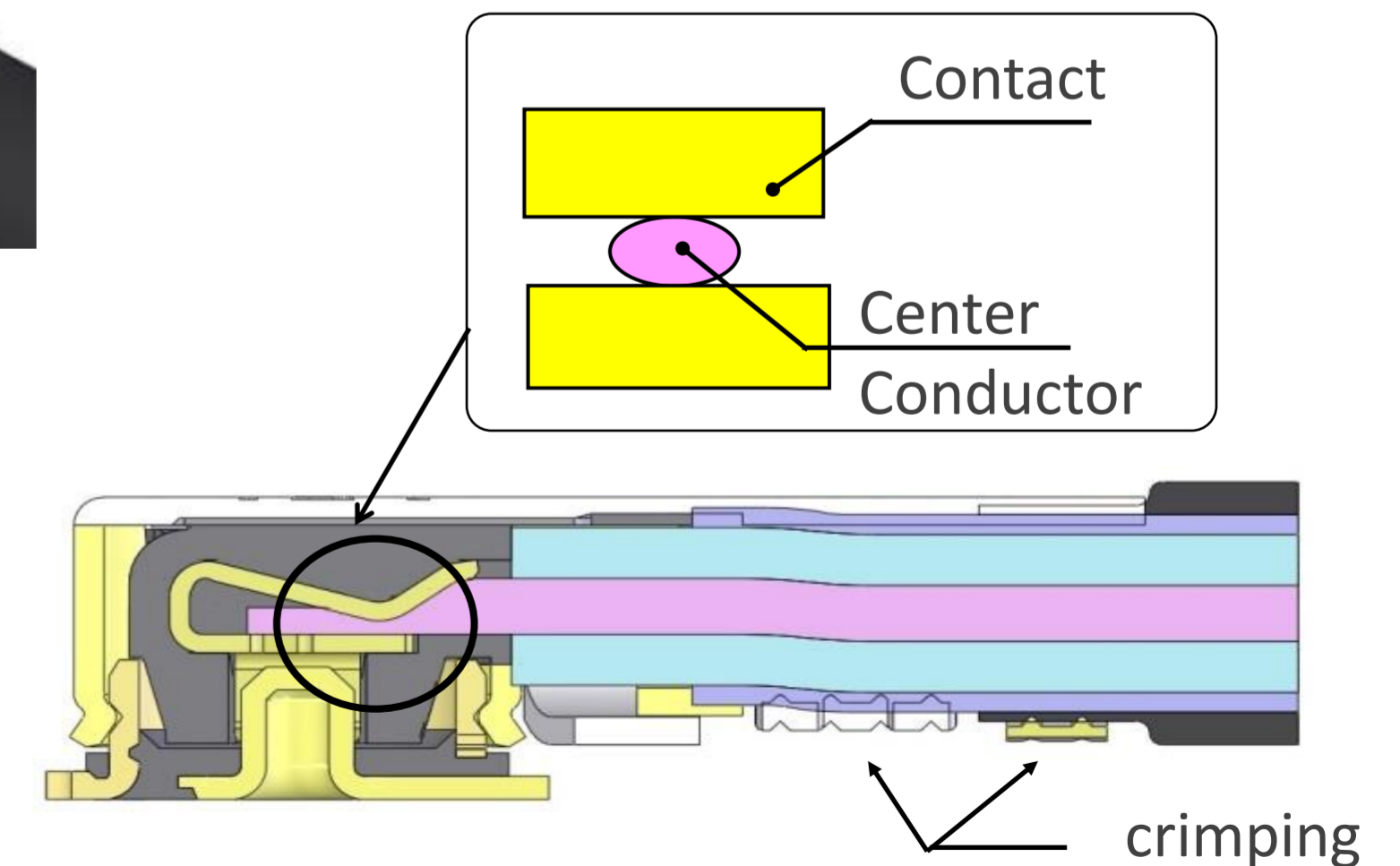

i-Fit[®] Technology: Solder-less crimp advantage versus soldering types

i-Fit[®] offers consistently tight range of performance

■ I-PEX i-Fit[®] solderless termination (MHF[®]5)
■ Solder termination

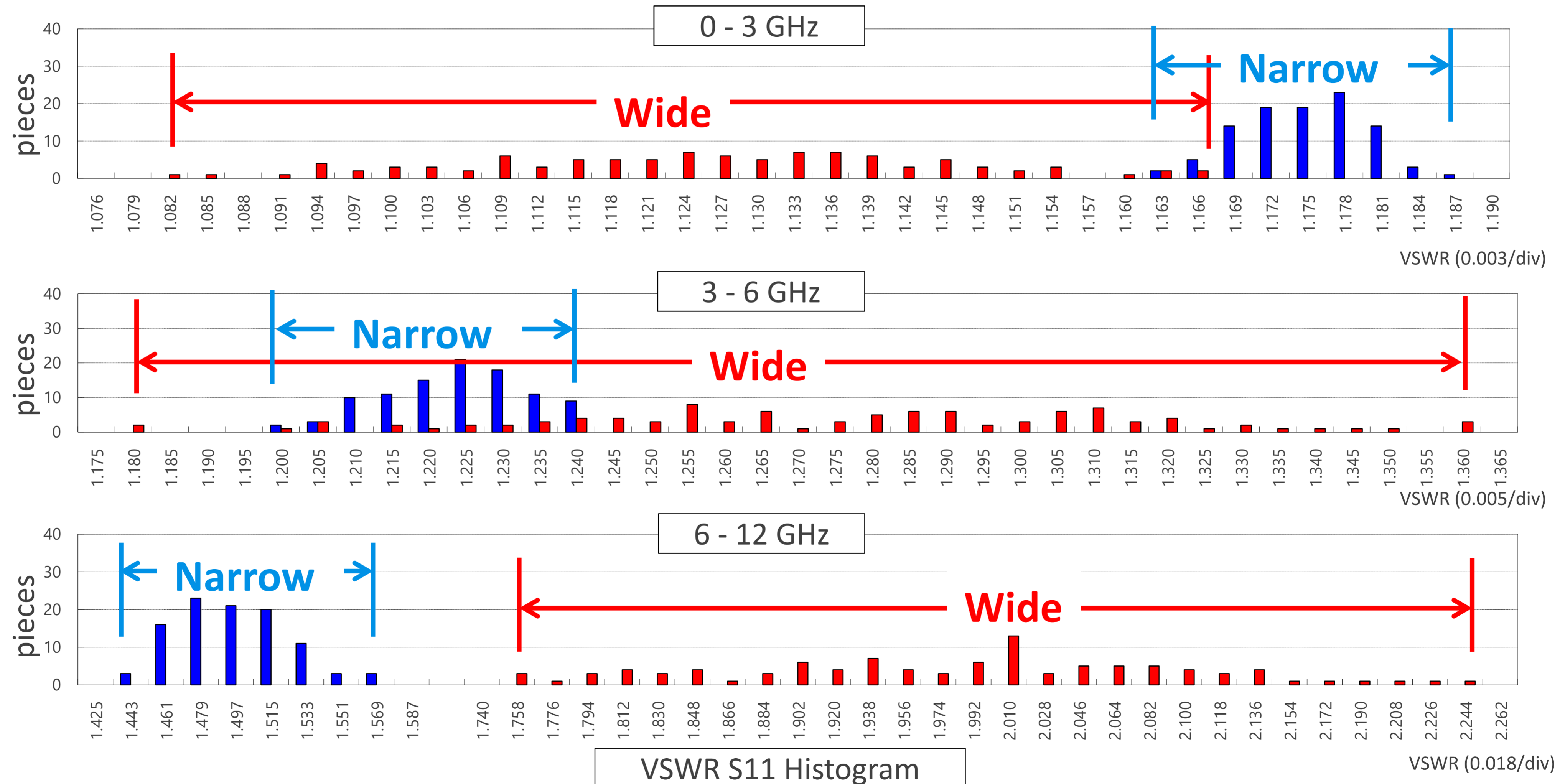

i-Fit[®] Technology: Solder-less crimp advantage versus manual soldering types

■ i-Fit[®] Semi-Auto Wiring Jig

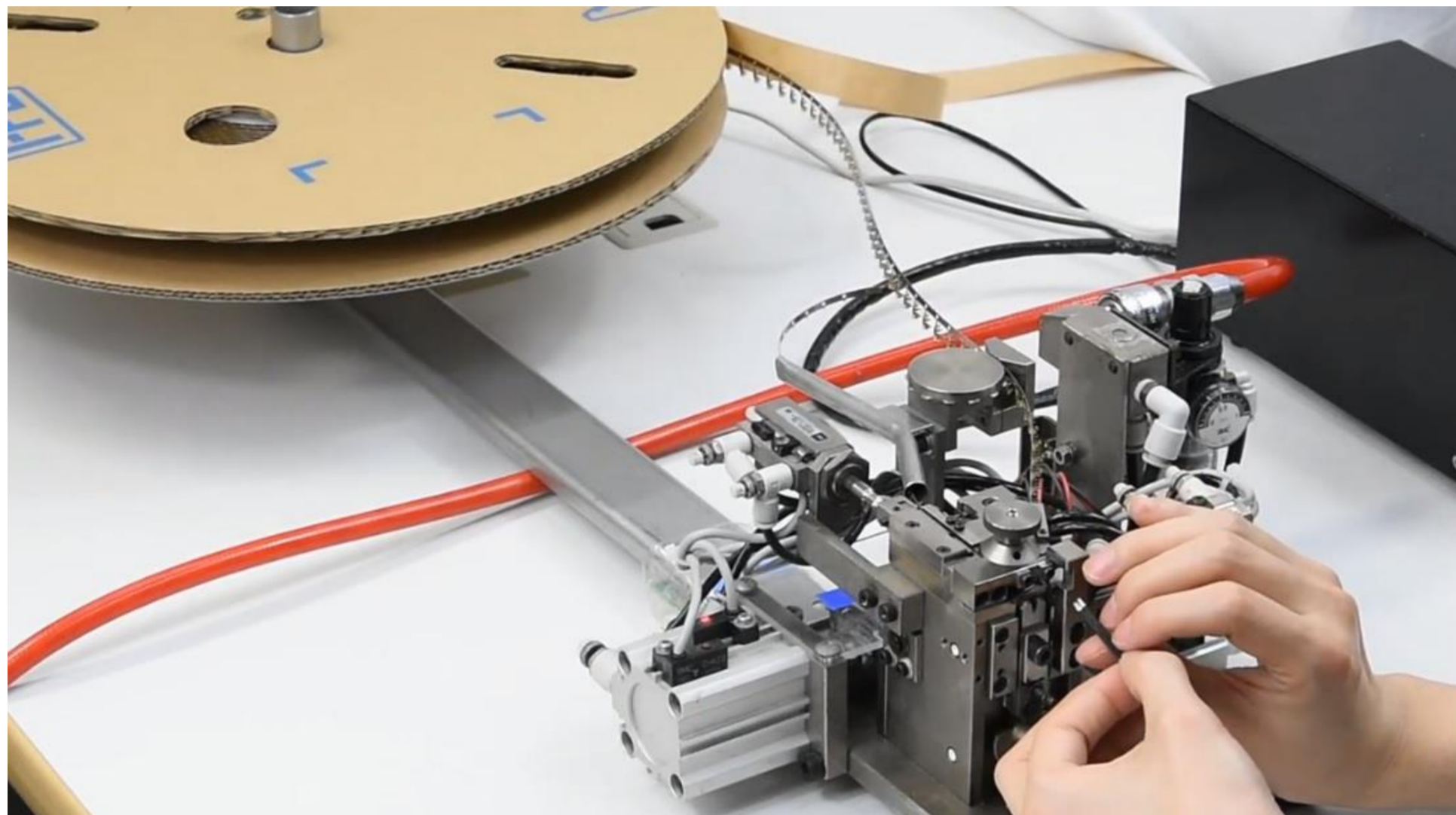

Significantly reduced tact time with i-Fit[®]

		I-PEX MHF [®] "i-Fit [®] "	Manual Soldering
Tact time	Cable strip	Same tact time	
	Termination	6 seconds/ea.	30 seconds/ea.
Qty of cable assemblies a worker can make per month		105,600 assemblies	21,120 assemblies
Number of operator needed	1M cable assemblies/month	10	48
	2M cable assemblies/month	19	95

*Calculated based on operation hours of 22days/month (8hours/day)

I-PEX's i-Fit[®] technology has enabled antenna and harness makers to have the ability to terminate MHF[®] products in local production facilities. With over 1,000 [termination machines](#) in the field, more than 100 customers produce MHF[®] harnesses and antennas ensuring quality when using genuine MHF[®] components.



MHF[®] Harness Assemblies : Available for supply as a harness assemblies

I-PEX provides harness assemblies made with Fully Automated Machines and i-Fit[®] technology

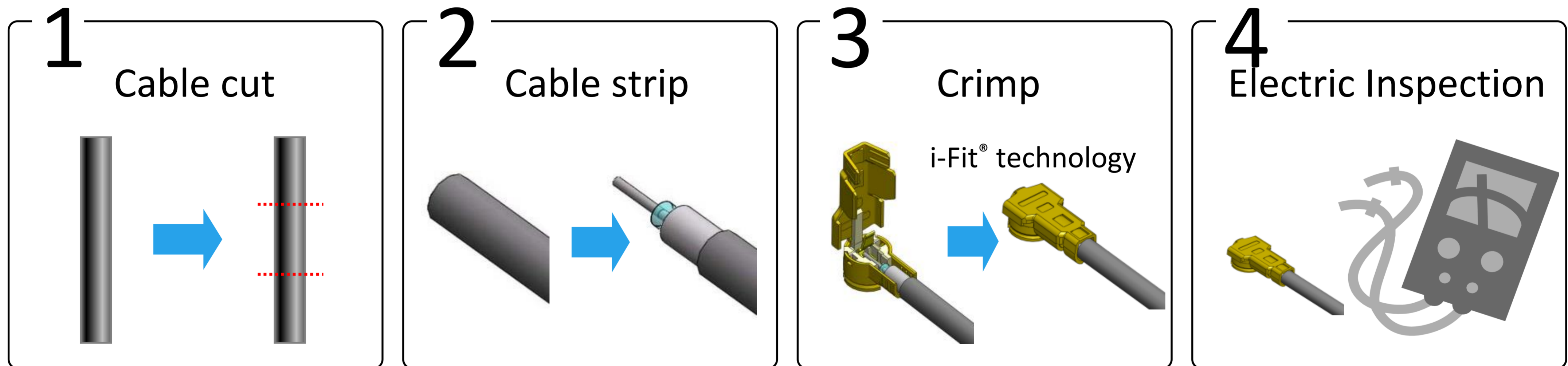
Fully Automated Process



MHF[®] Harness Assemblies : Cable clamp and surface mount clip

		Grounding clamp 3mm length	Grounding clamp 6mm length	Clip for grounding clamp MP-A series
Appearance (Reference)				
Coax O.D. (Center Conductor AWG)	1.37 mm (30)	●	●	● MP-A04 (P/N 3224-0001)
	1.13 mm (32)	●	●	● MP-A02 (P/N 3182-0001)
	0.81 mm (36)	●	●	● MP-A01 (P/N 3096-0001)
	0.64 mm (36)	●	●	● MP-A03 (P/N 3186-0001)

Minimum distance between clamps

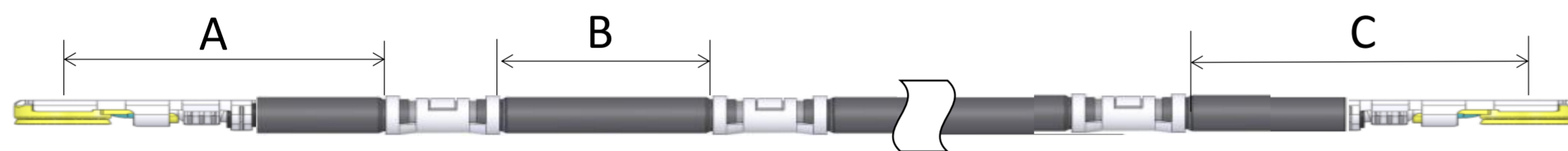

A	B	C
12mm min.	10mm min.	10mm min.

*Depending on the harness specifications, this condition may not apply. Please contact our sales for details.

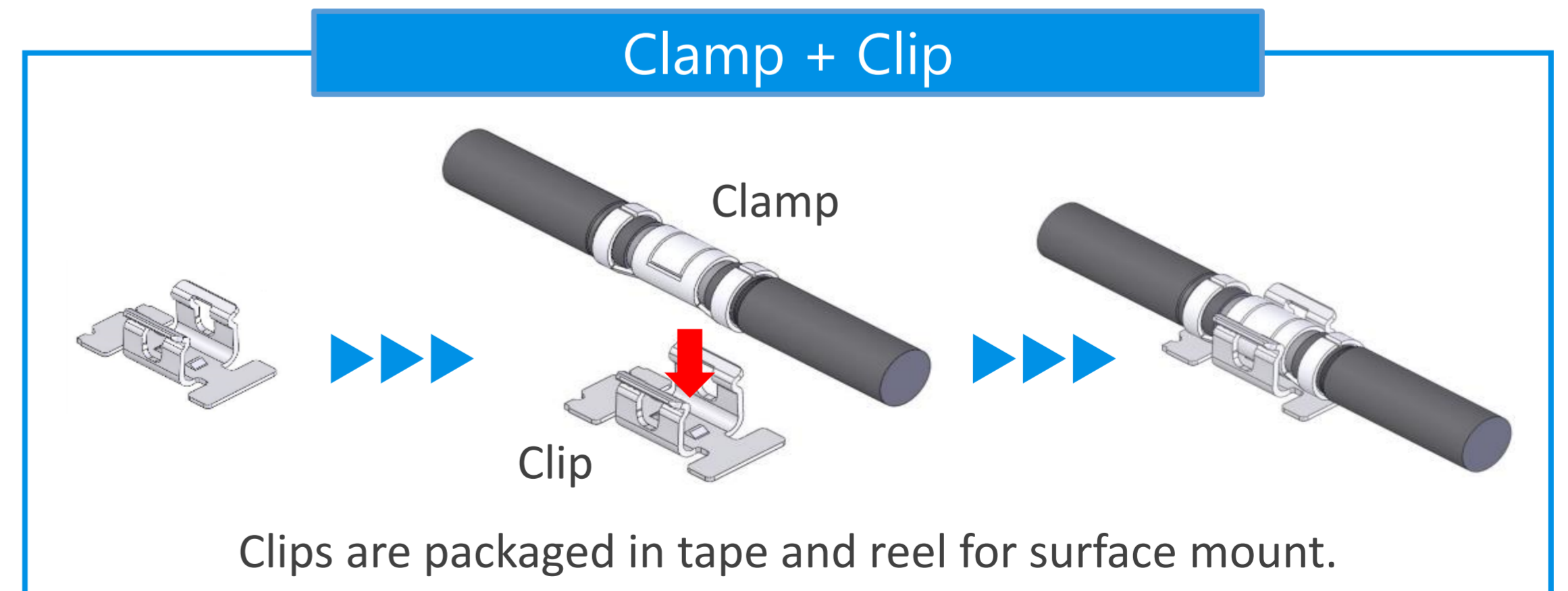

MHF[®] Harness Assemblies : Cable clamp and surface mount clip

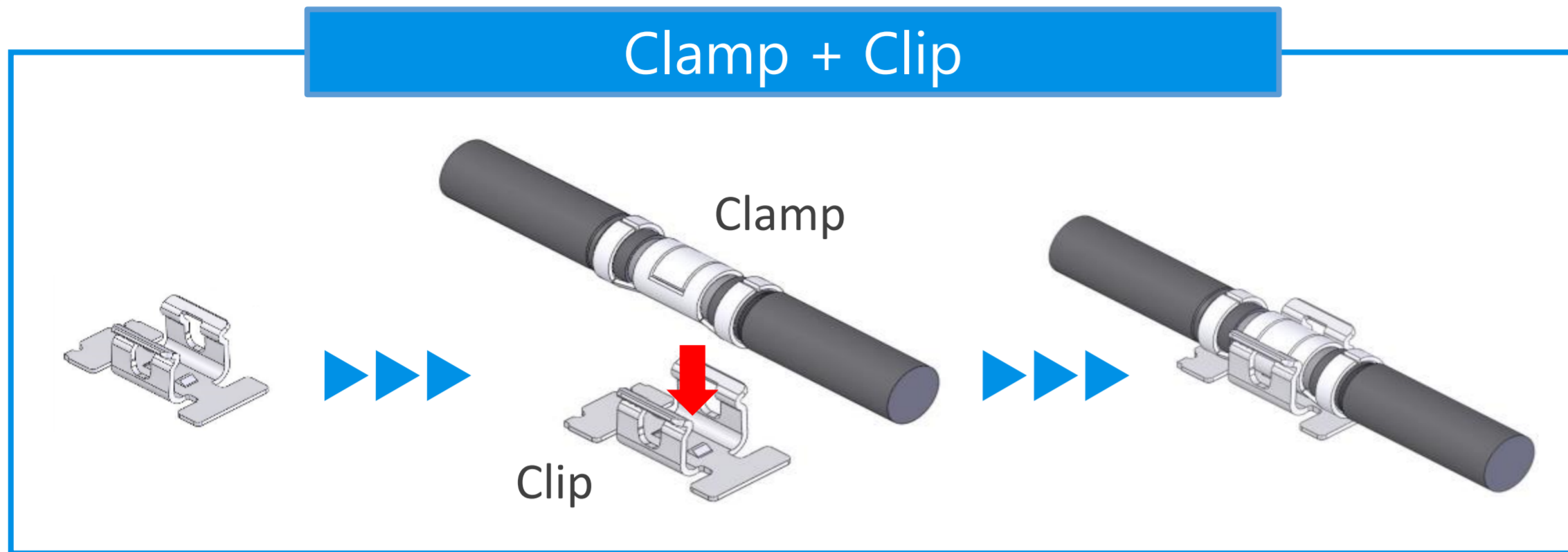

Provides EMI improvements for dense RF applications

Ideal for 5G mmWave applications

Electric Field Simulations

MHF[®] 4L Harness (without Clamp & Clip)

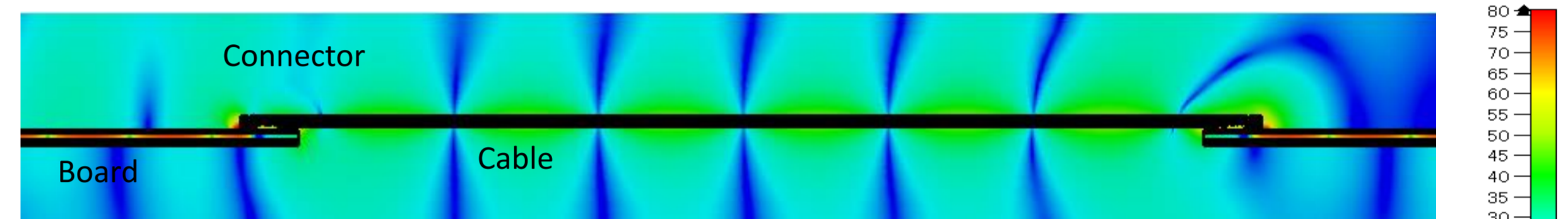

MHF[®] 7S Harness (without Clamp & Clip)



MHF[®] 7S Harness with Clamp & Clip

□ : Clamp & Clip points

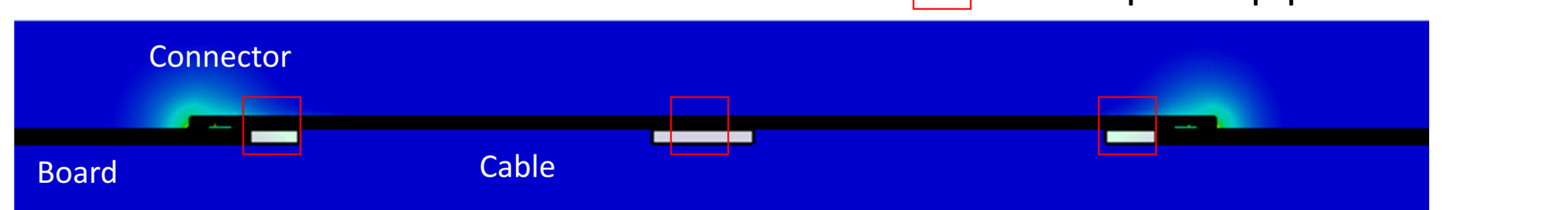

Reduces tact time for assembly and rework

MP-A & Clamp

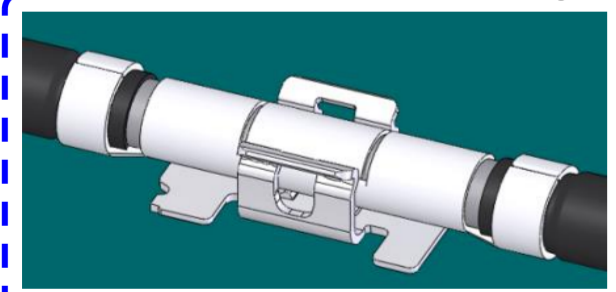

Soldering

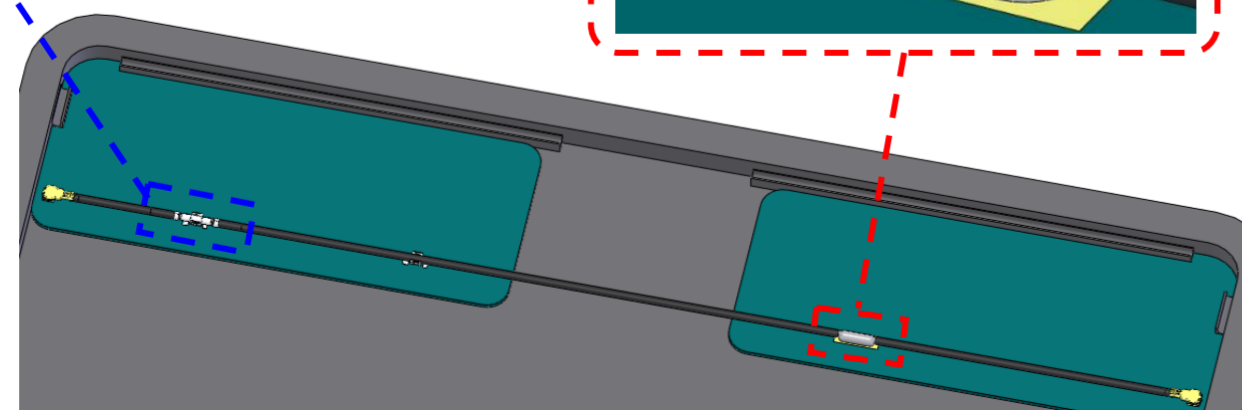
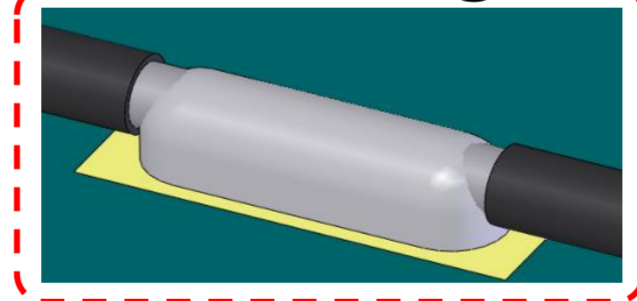

Cable insertion loss : MHF[®] I

■ Harness Length (mm) vs Insertion Loss (S21)

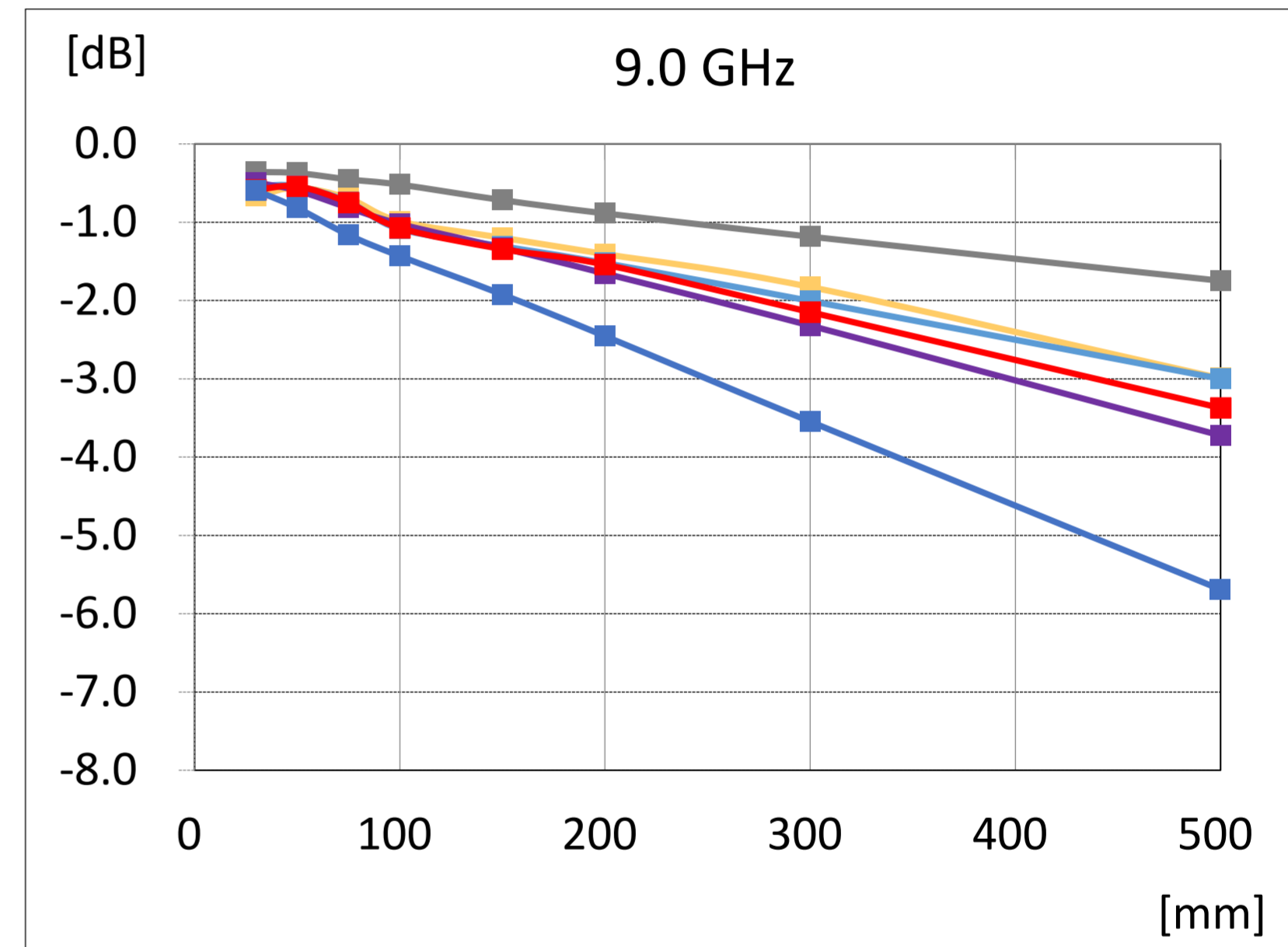
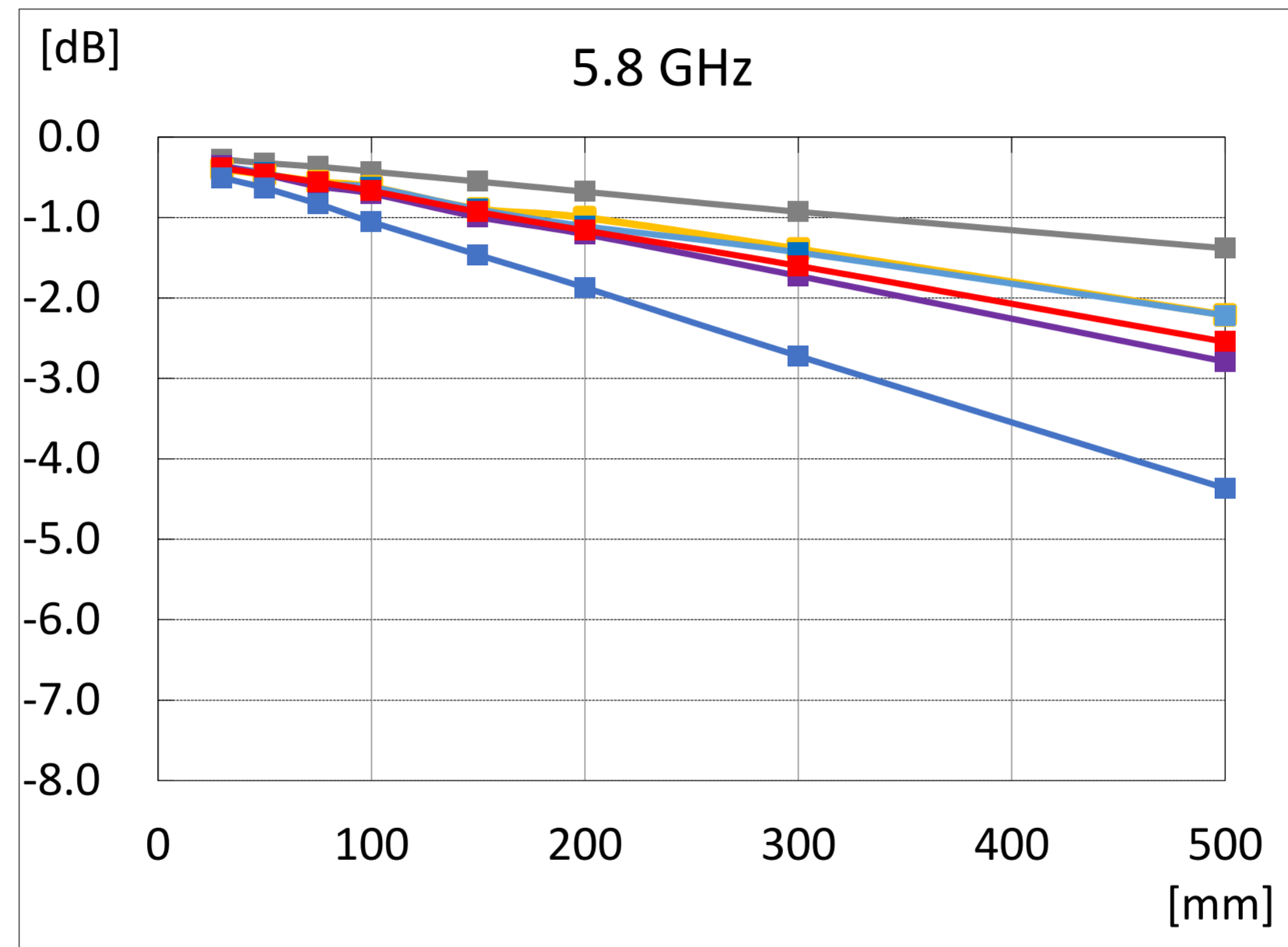
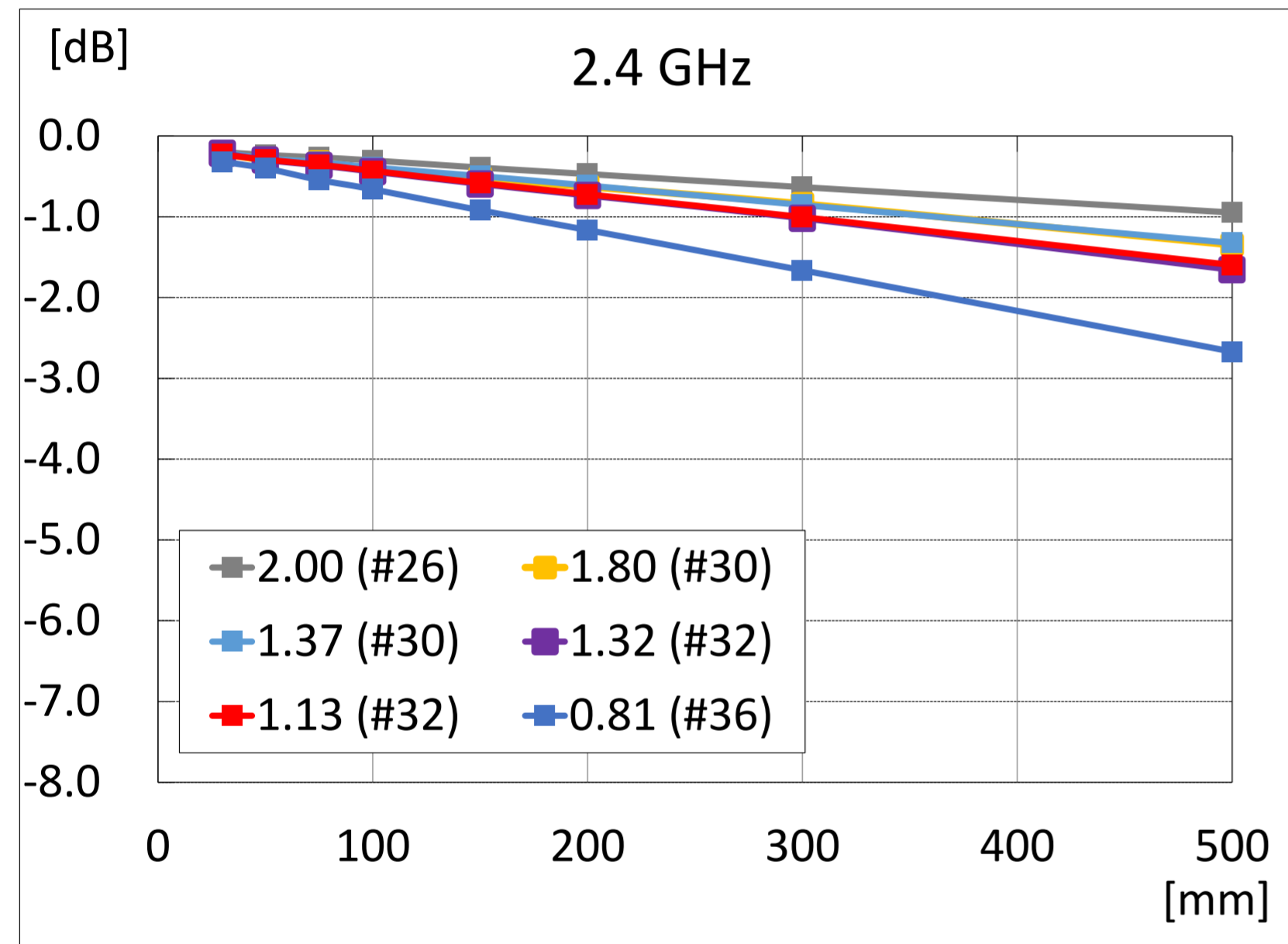

Cable insertion loss : MHF[®] 4

■ Harness Length (mm) vs Insertion Loss (S21)

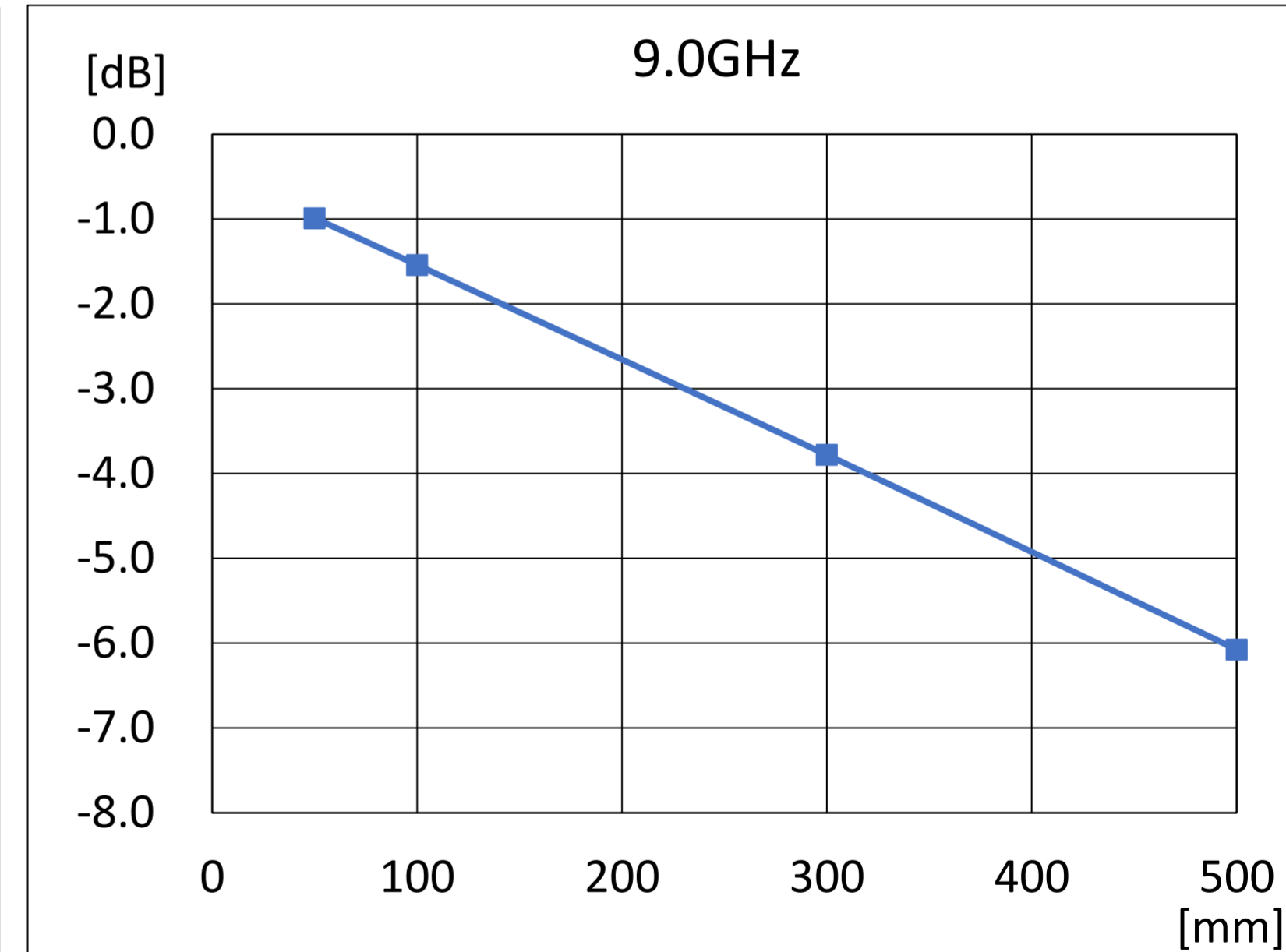
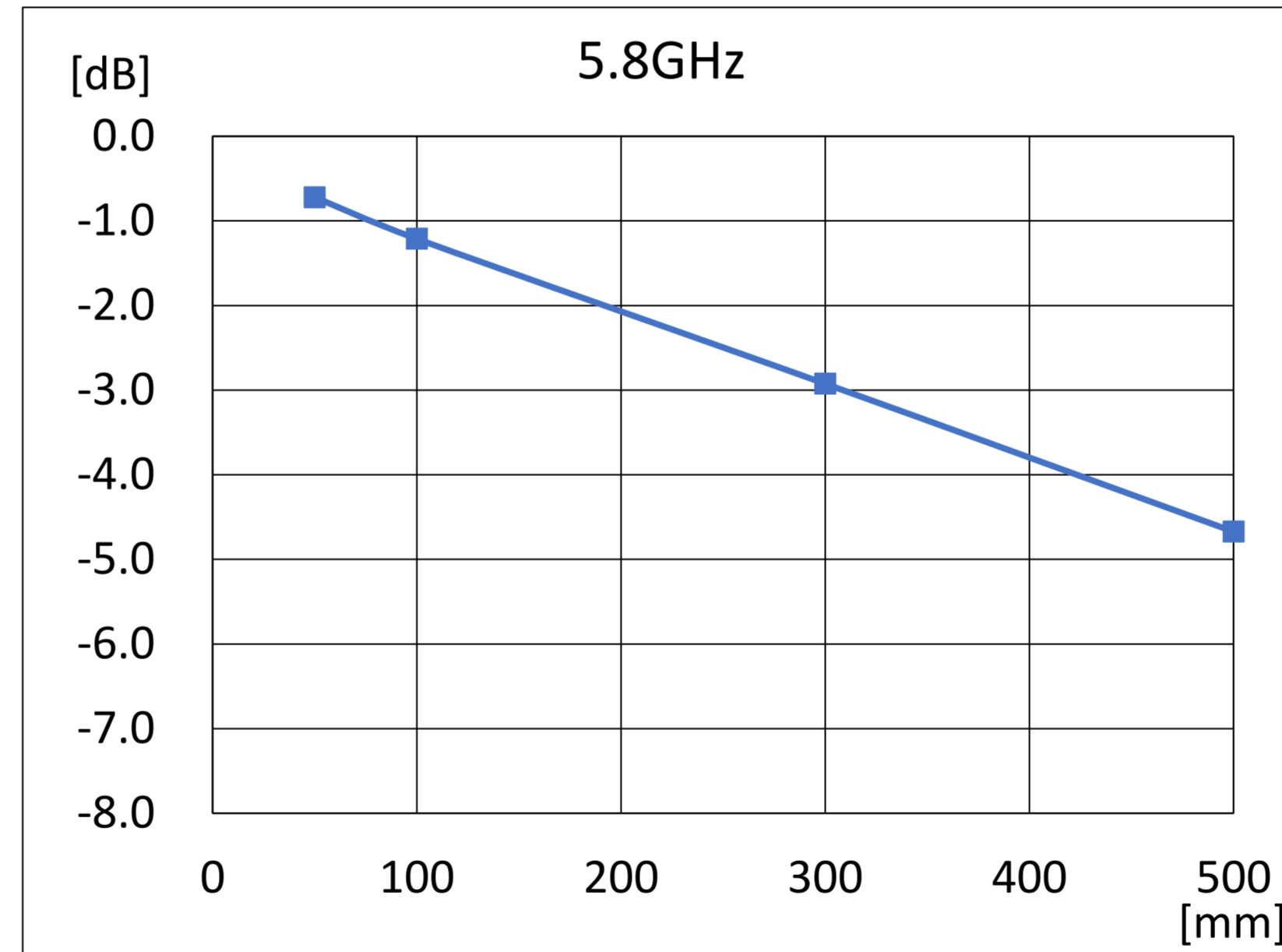
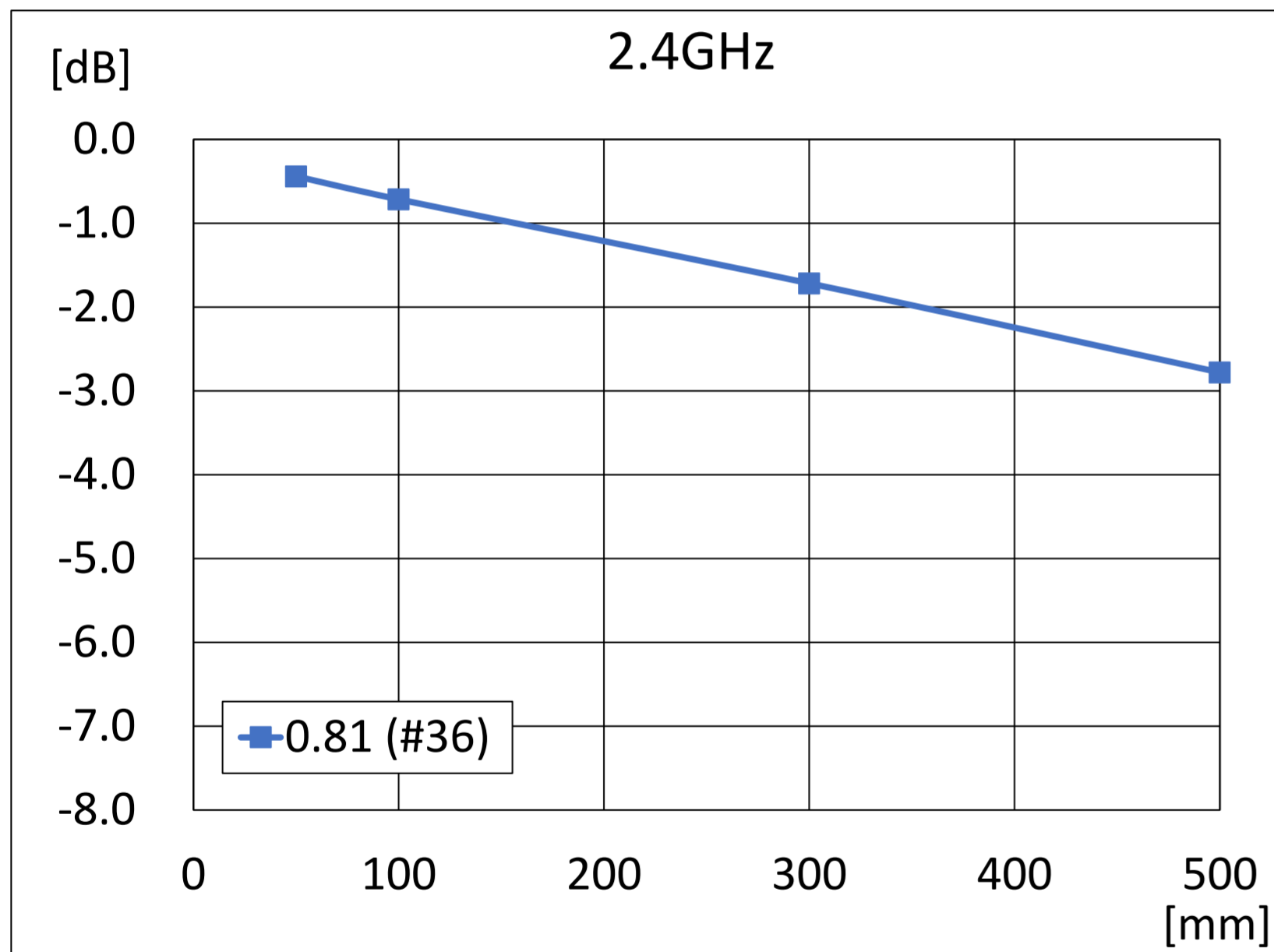

Cable insertion loss : MHF[®] 4L

■ Harness Length (mm) vs Insertion Loss (S21)

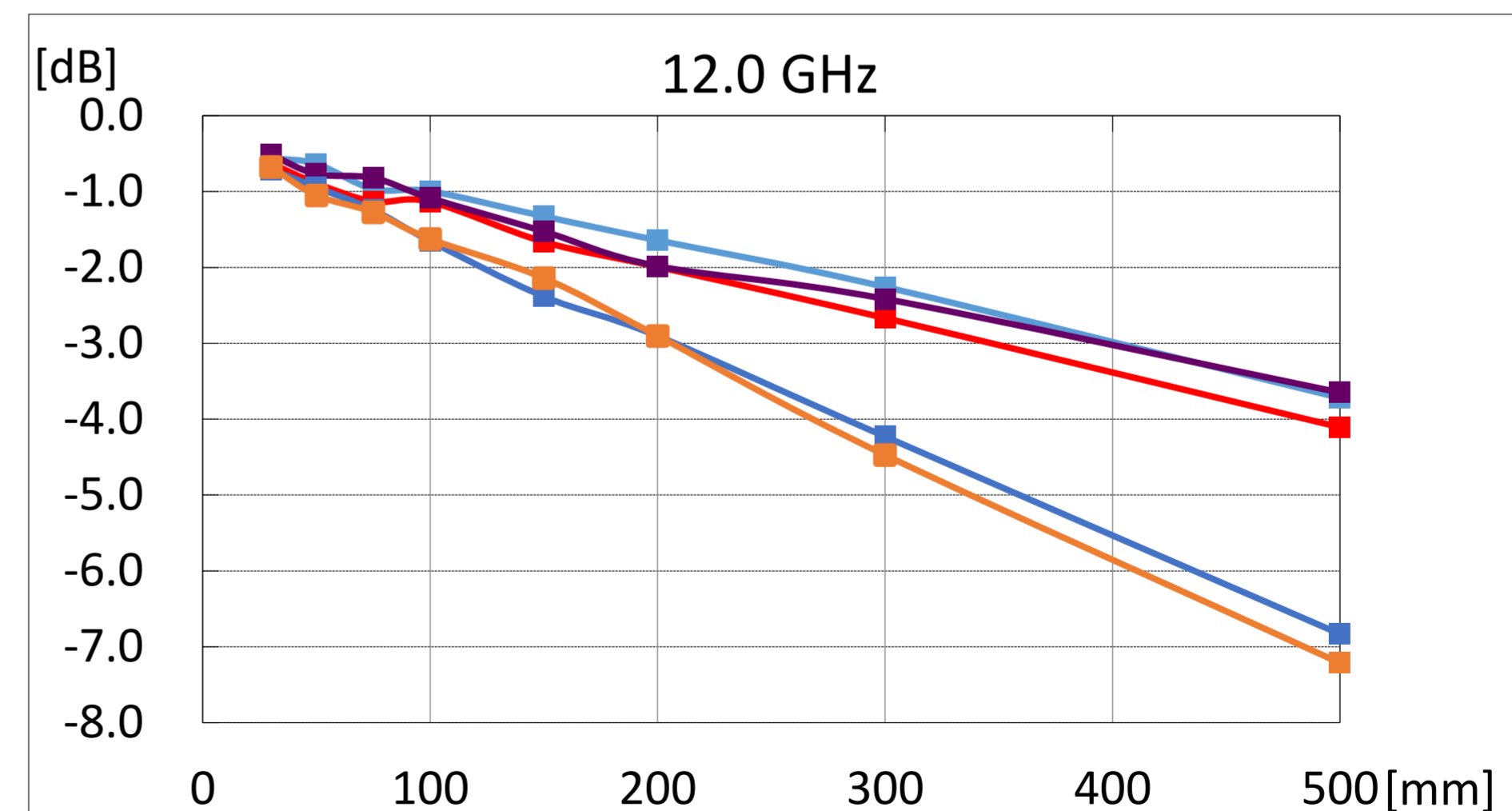
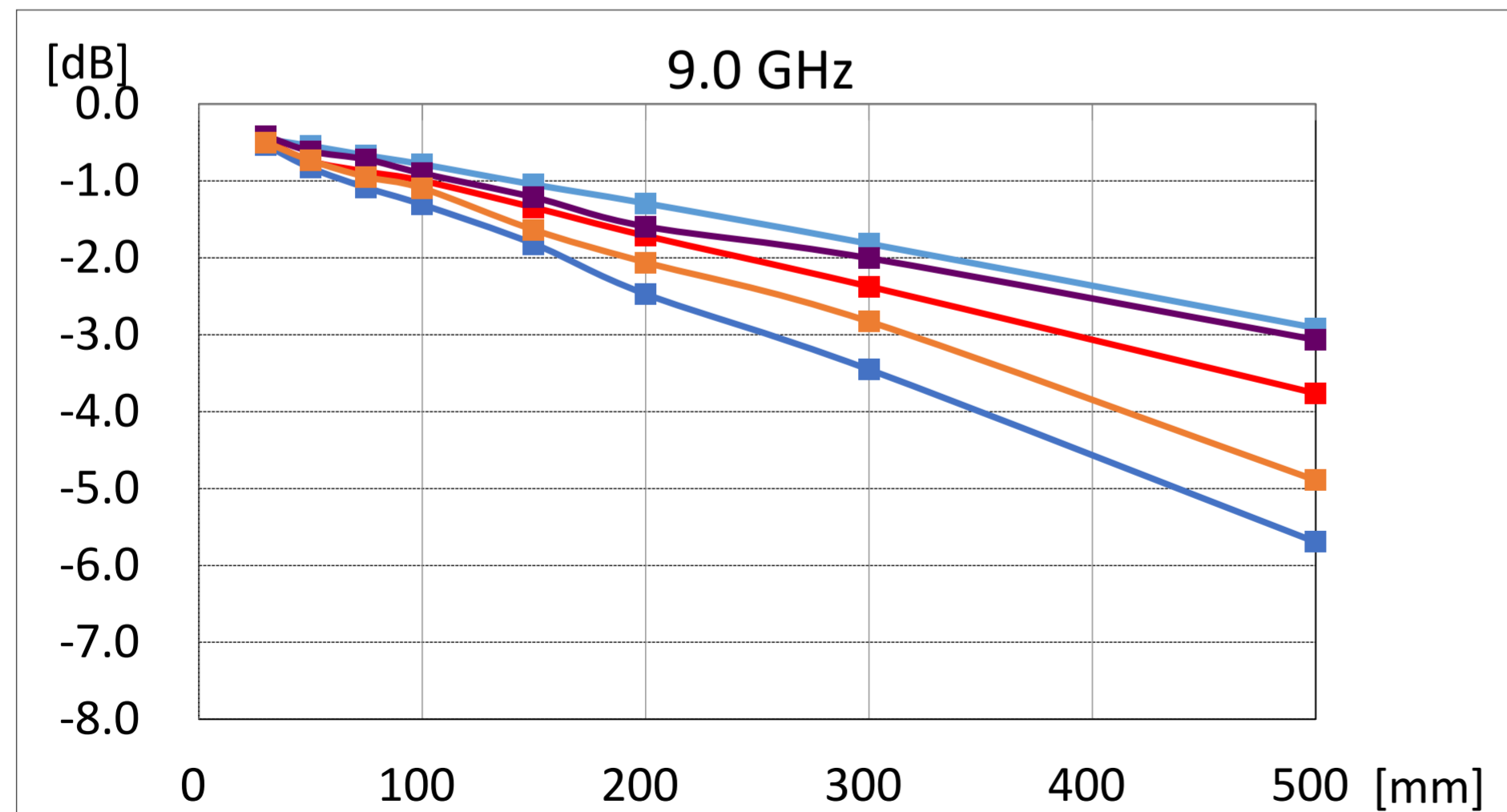
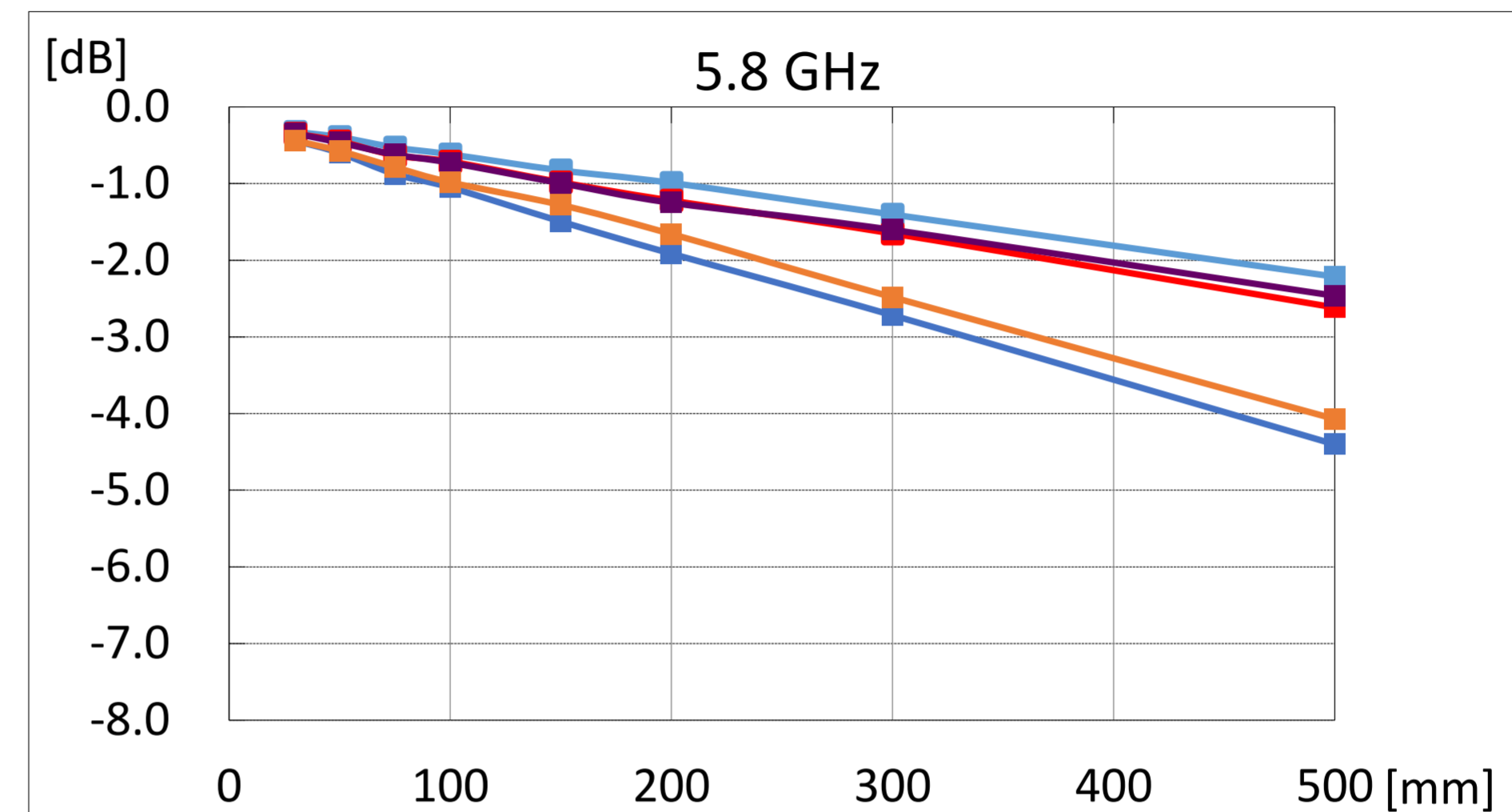
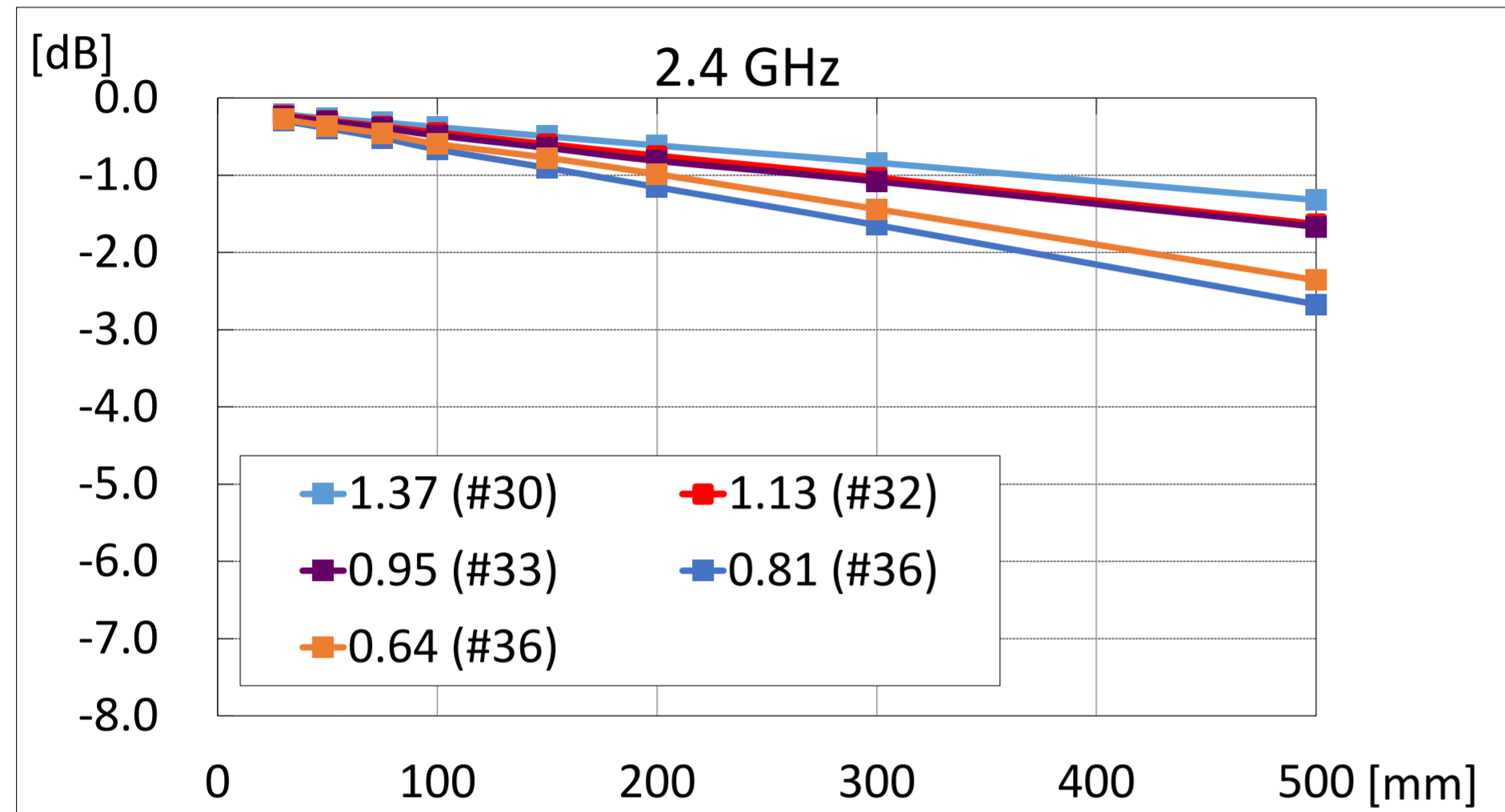

Cable insertion loss : MHF[®] 5

■ Harness Length (mm) vs Insertion Loss (S21)

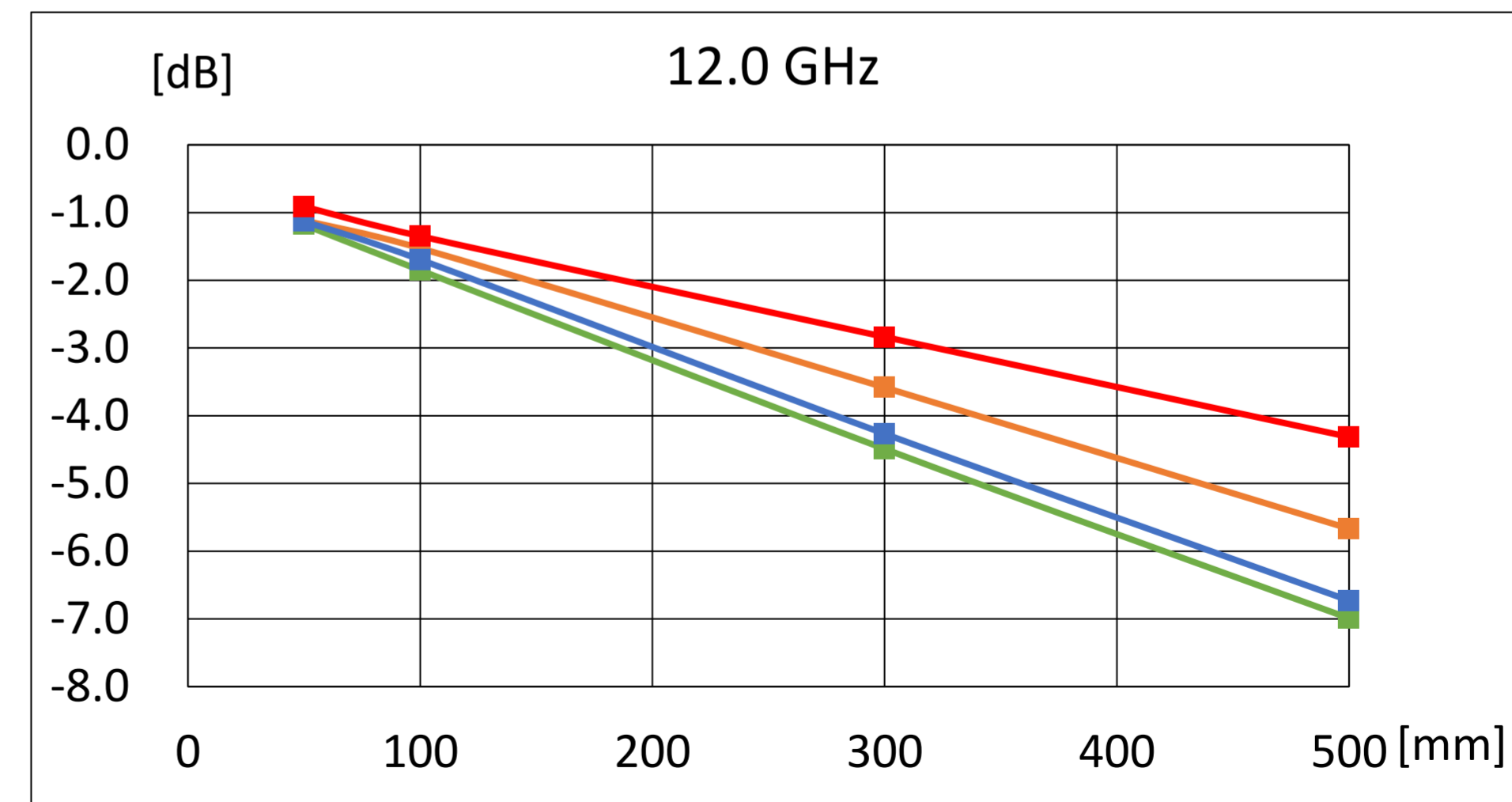
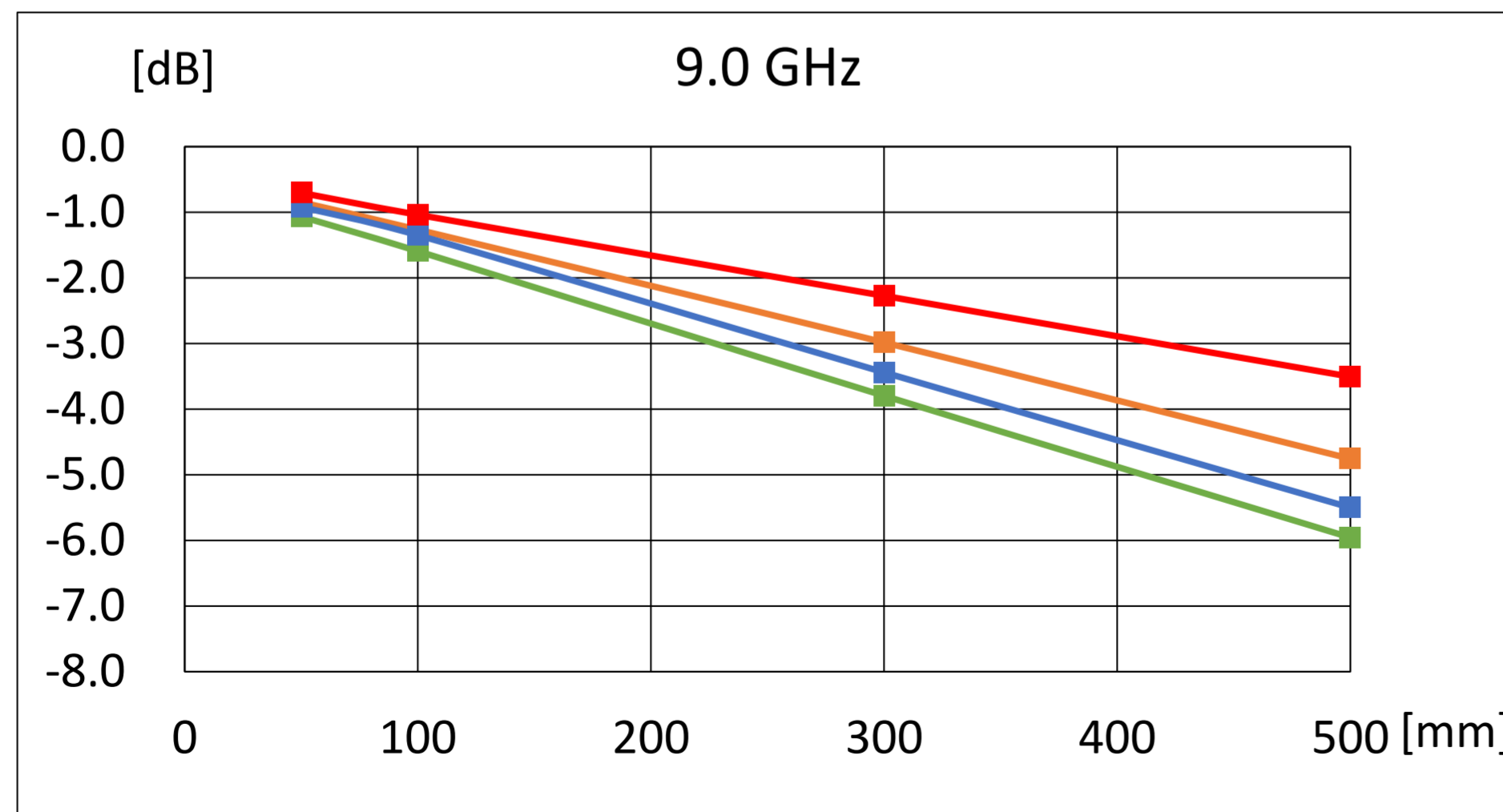
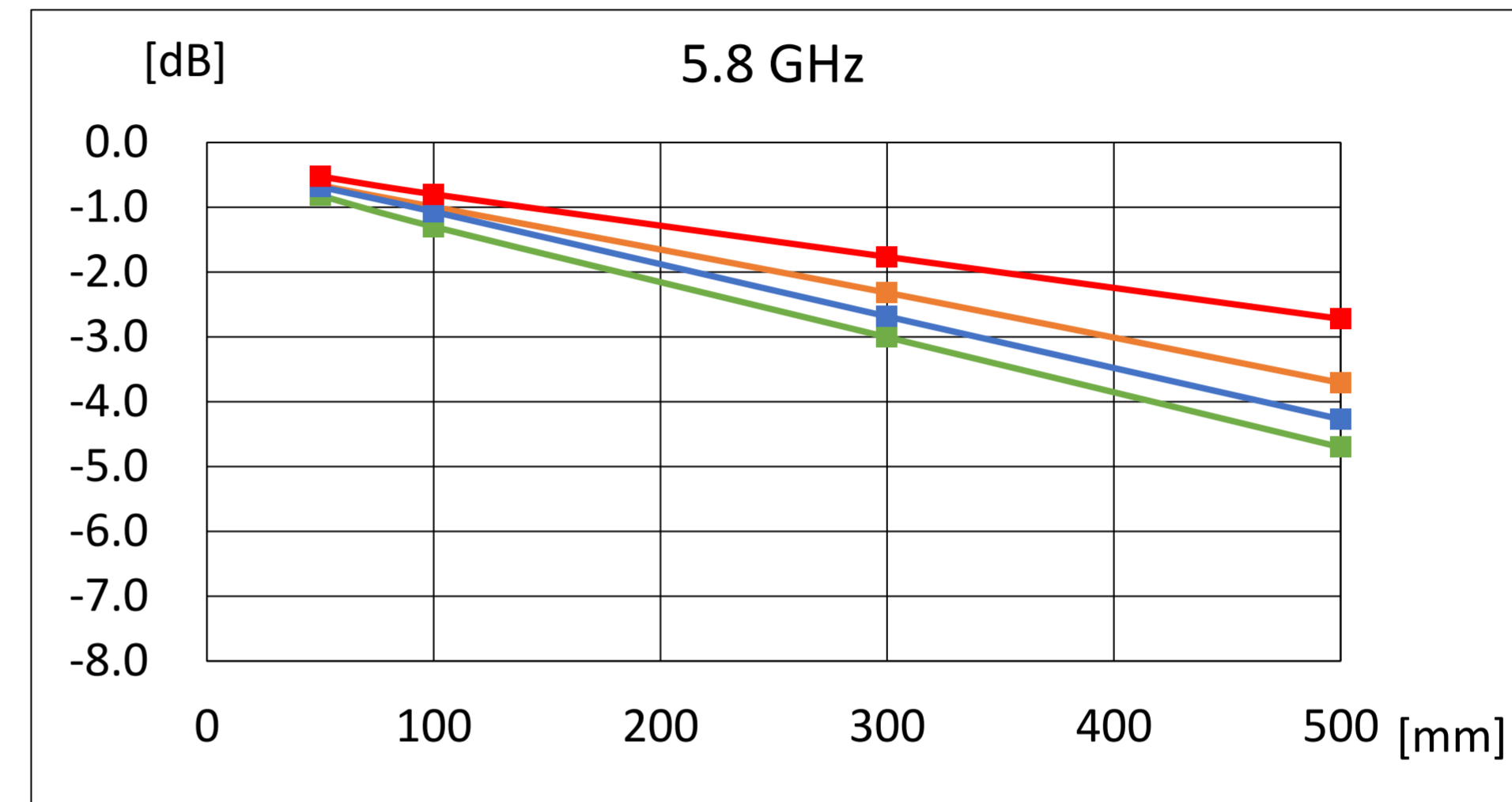
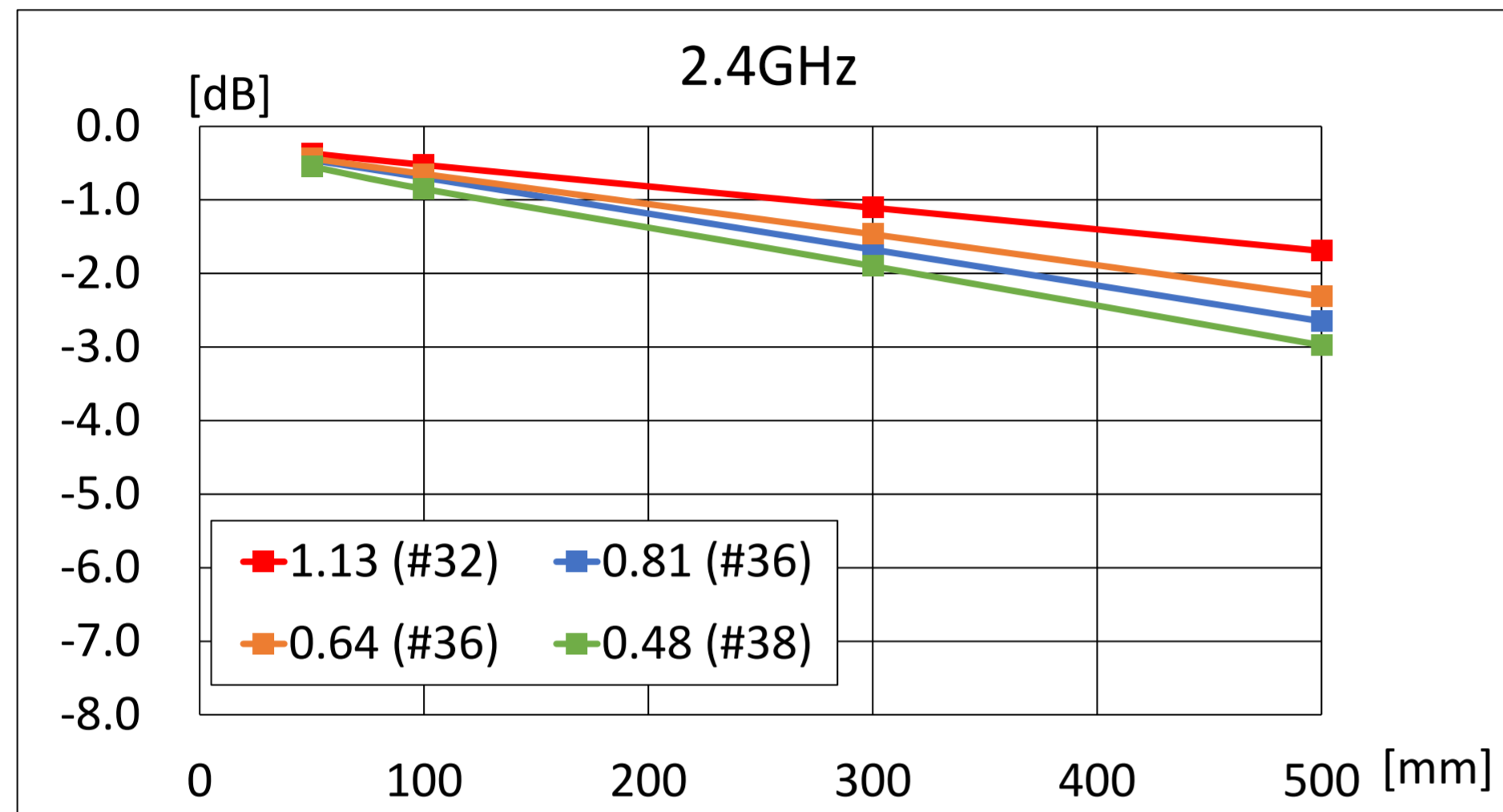

Cable insertion loss : MHF[®] 5L

■ Harness Length (mm) vs Insertion Loss (S21)

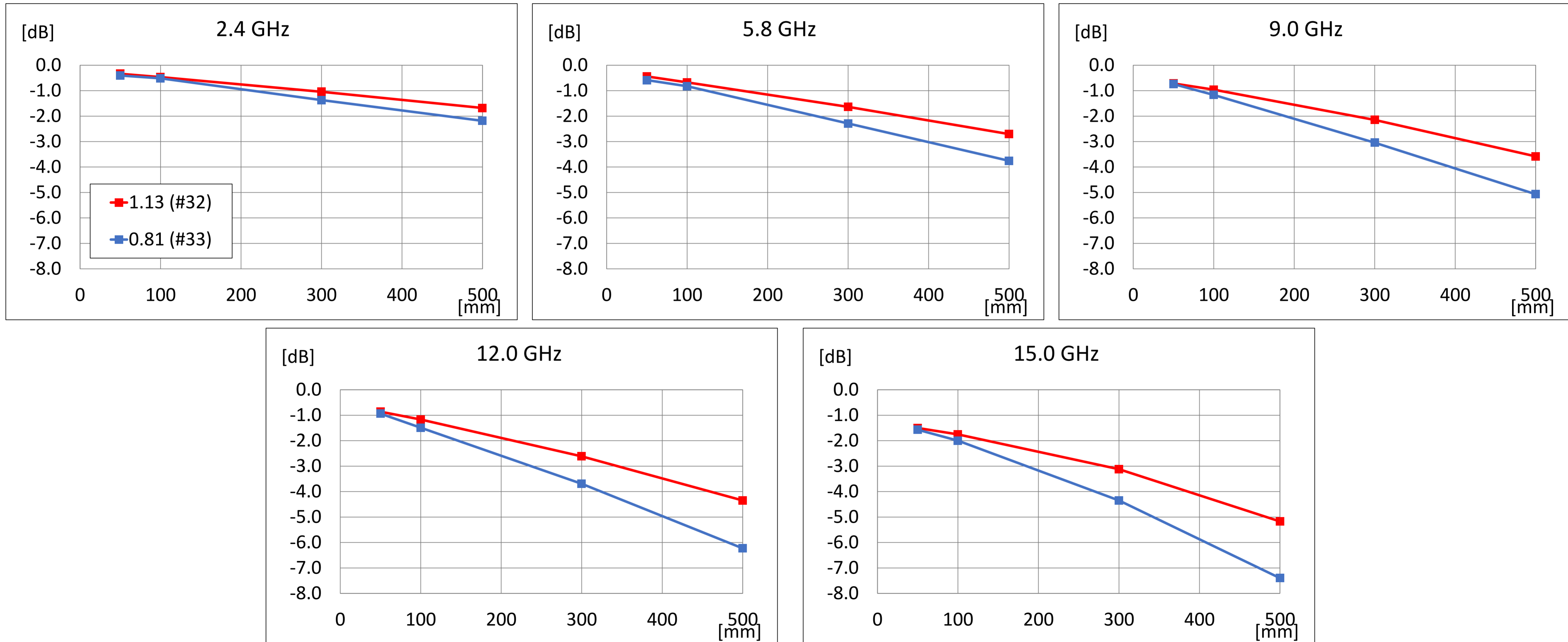

Cable insertion loss : MHF[®] 7S

■ Harness Length (mm) vs Insertion Loss (S21)

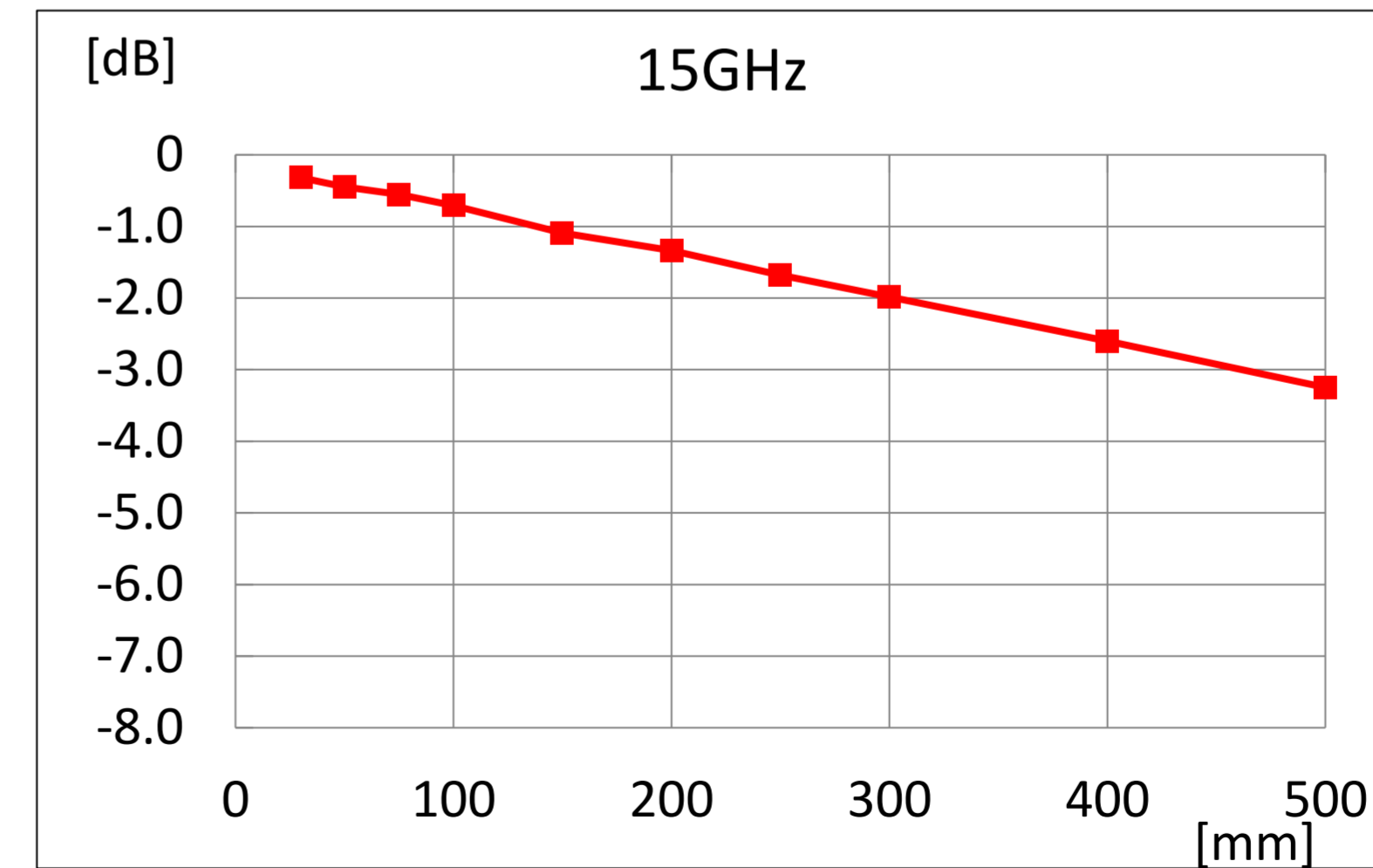
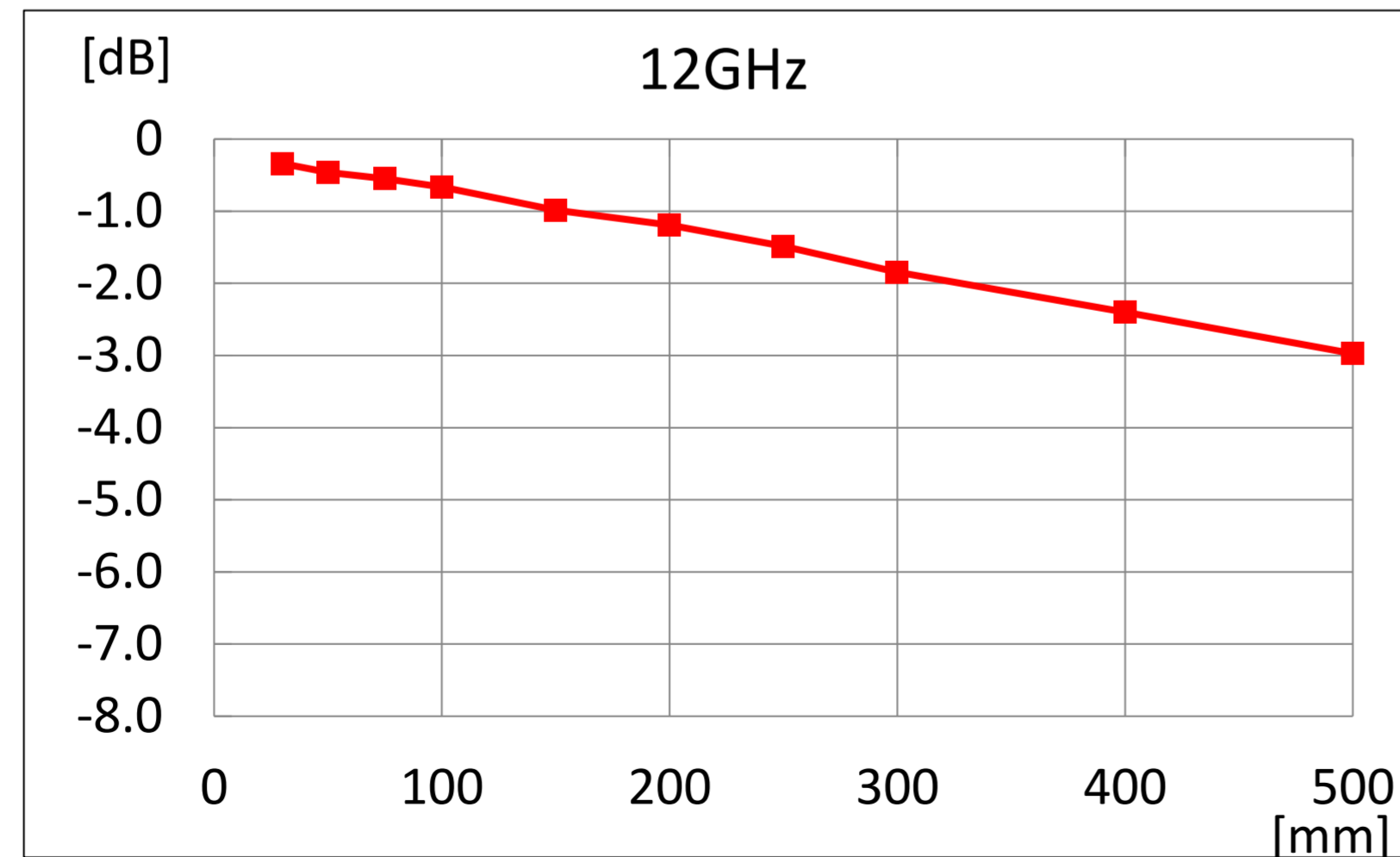
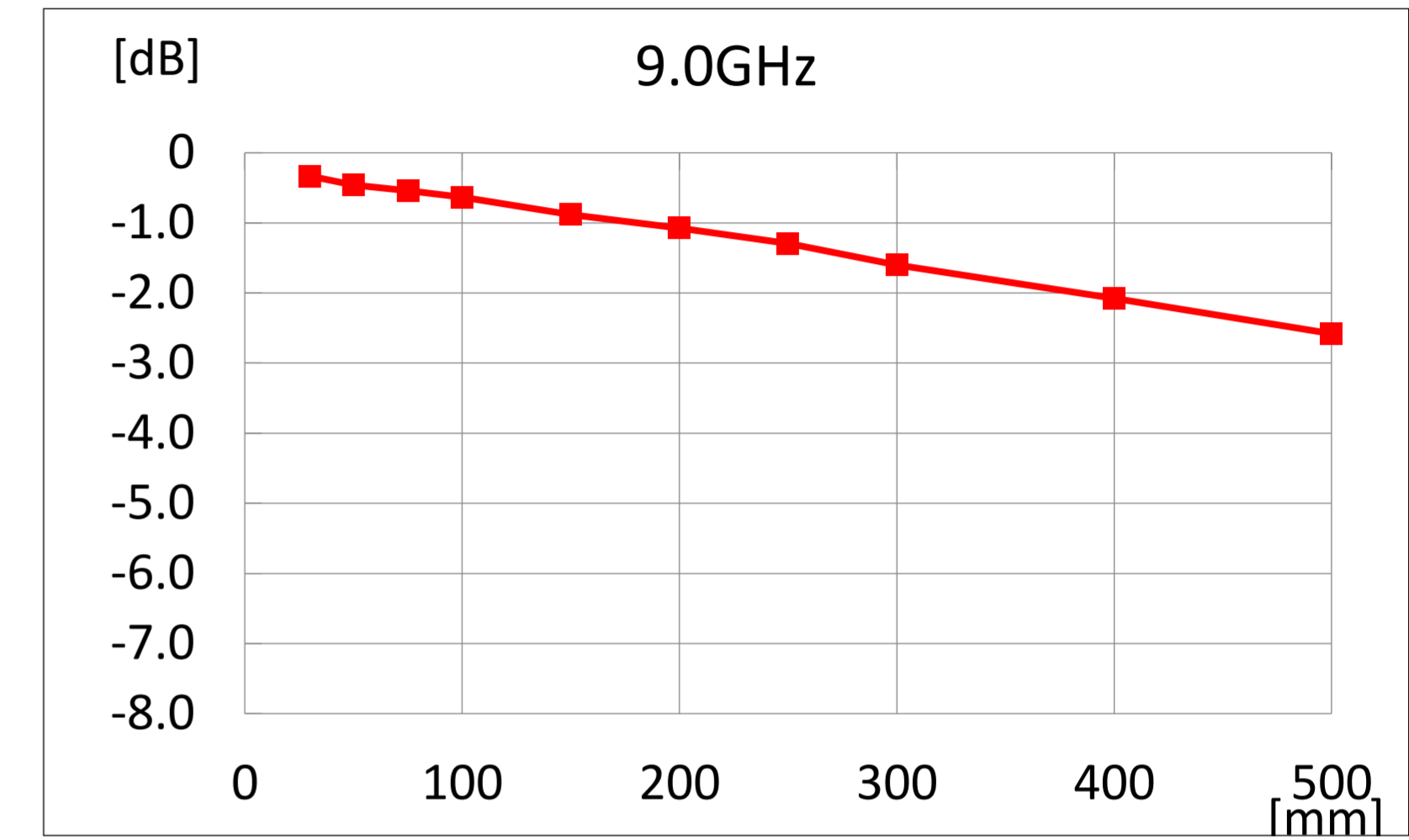
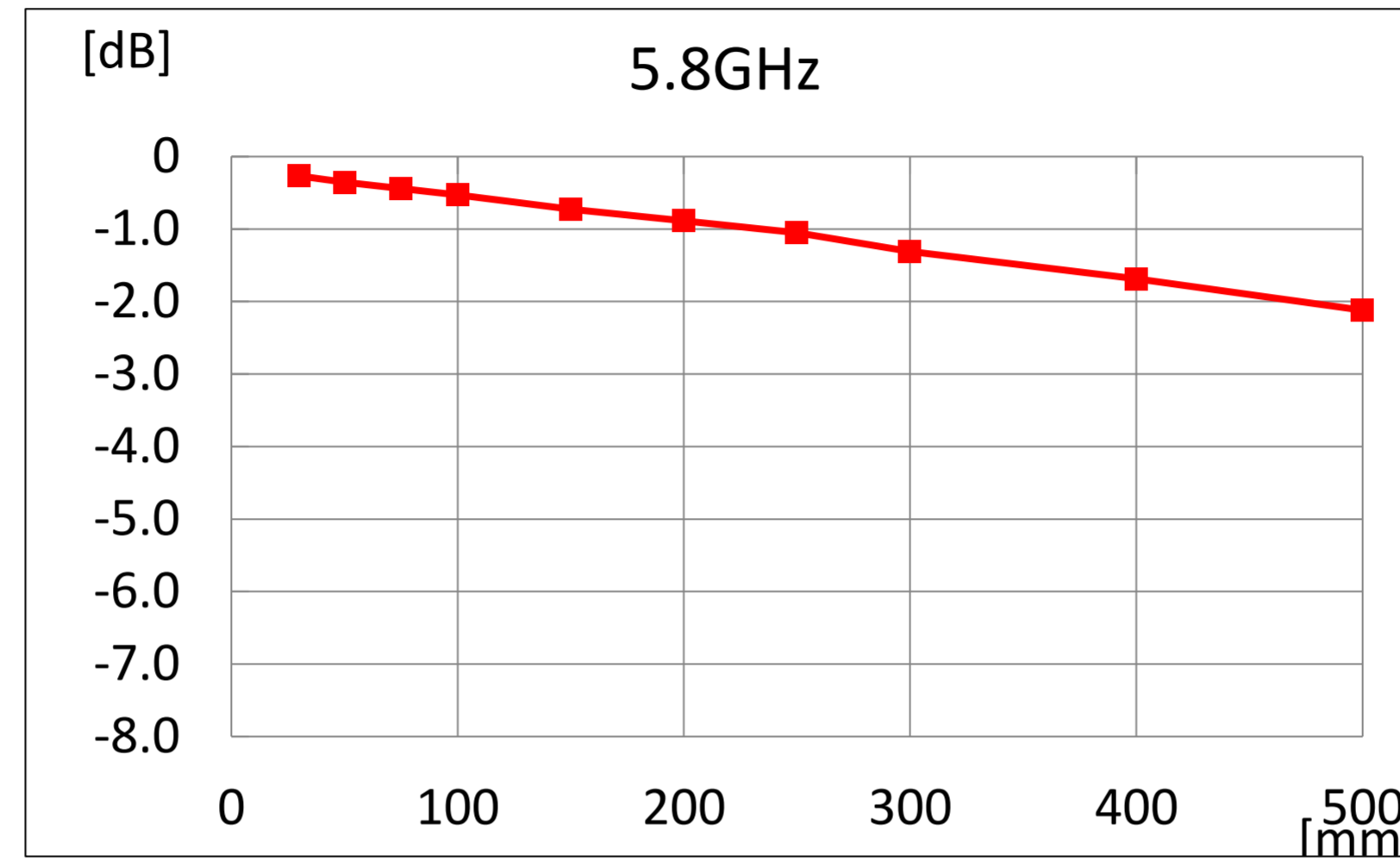
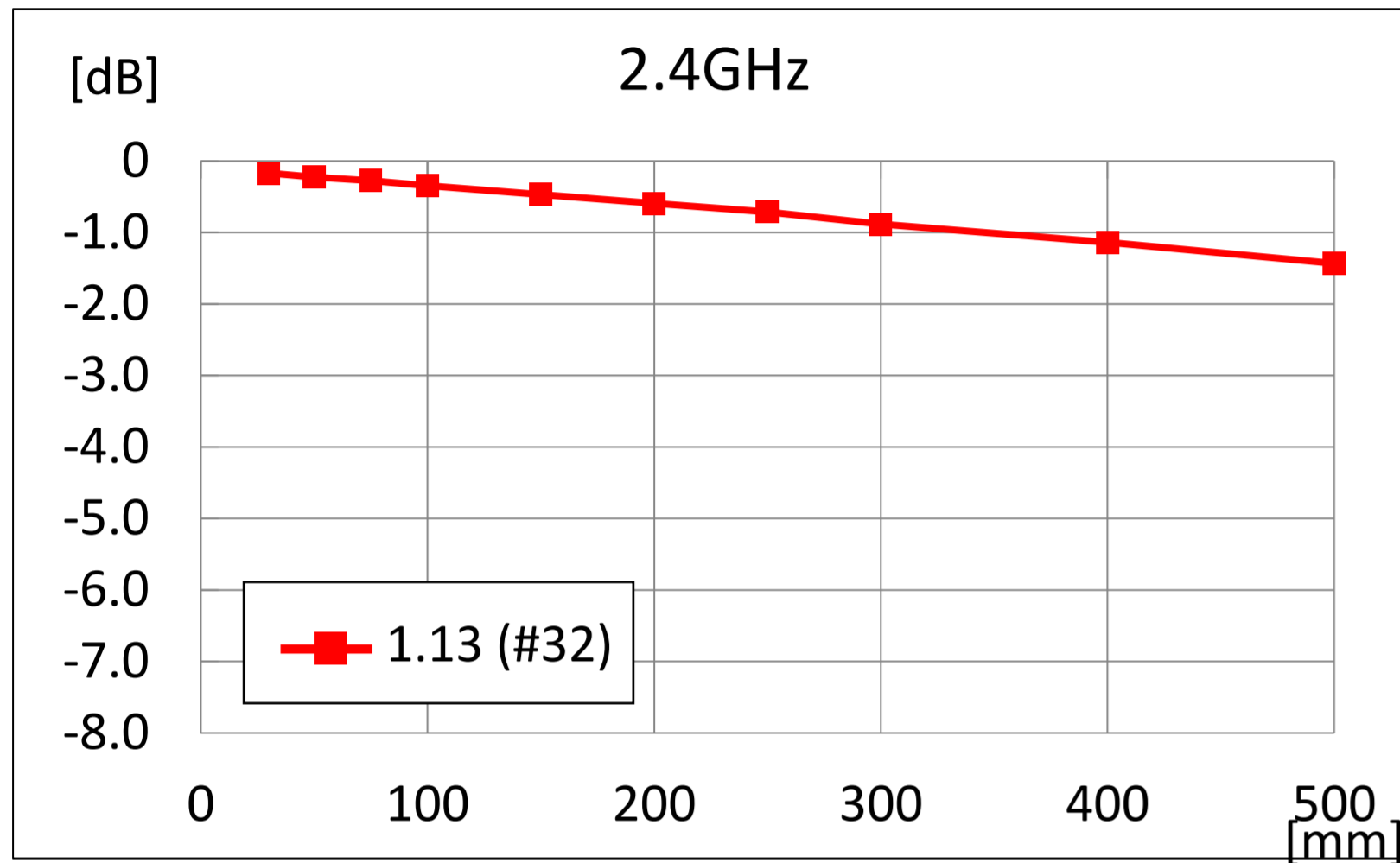

Cable insertion loss : MHF[®]-SW23

■ Harness Length (mm) vs Insertion Loss (S21)

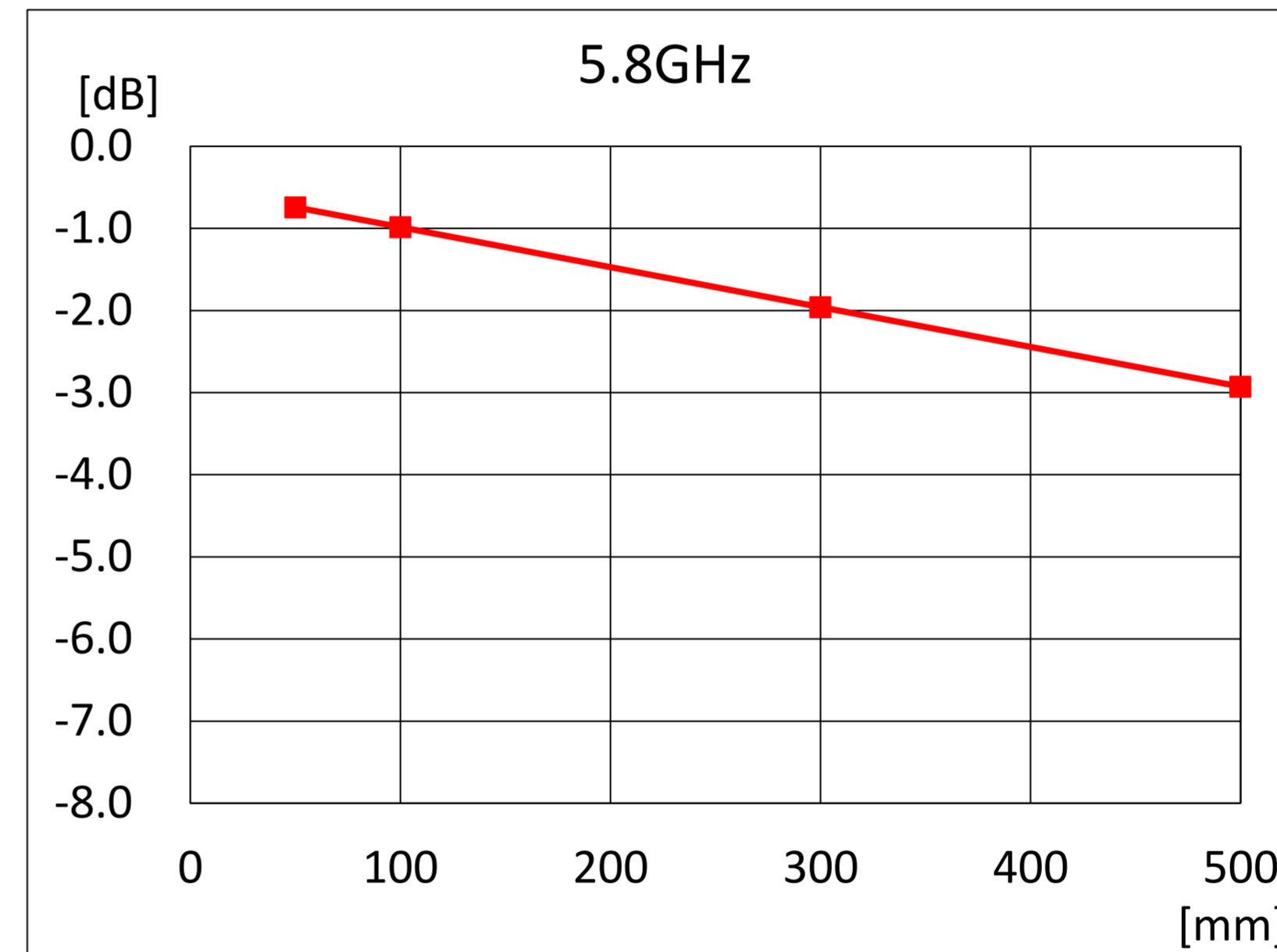
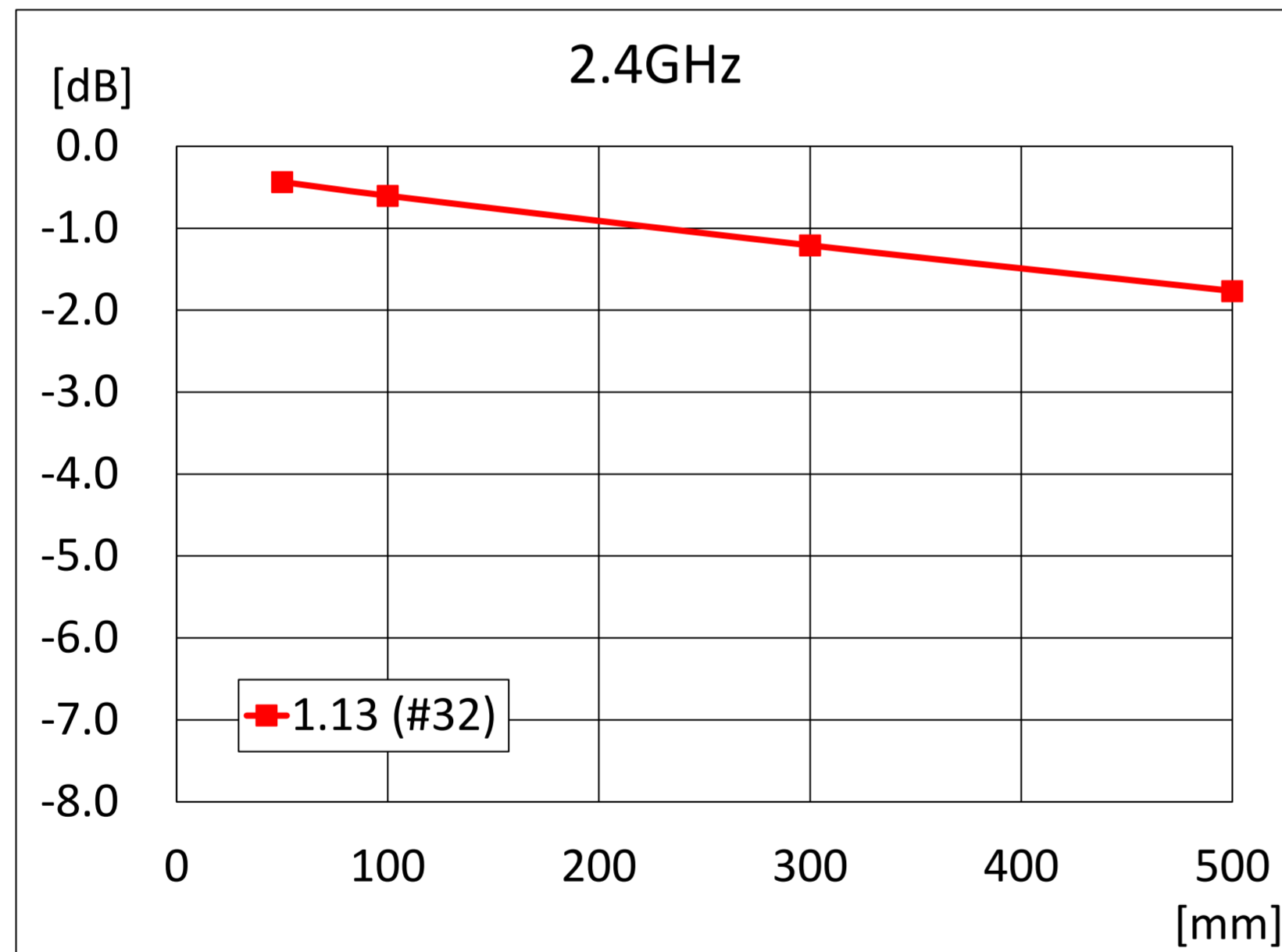

Cable insertion loss : MHF[®]-TI

■ Harness Length (mm) vs Insertion Loss (S21)

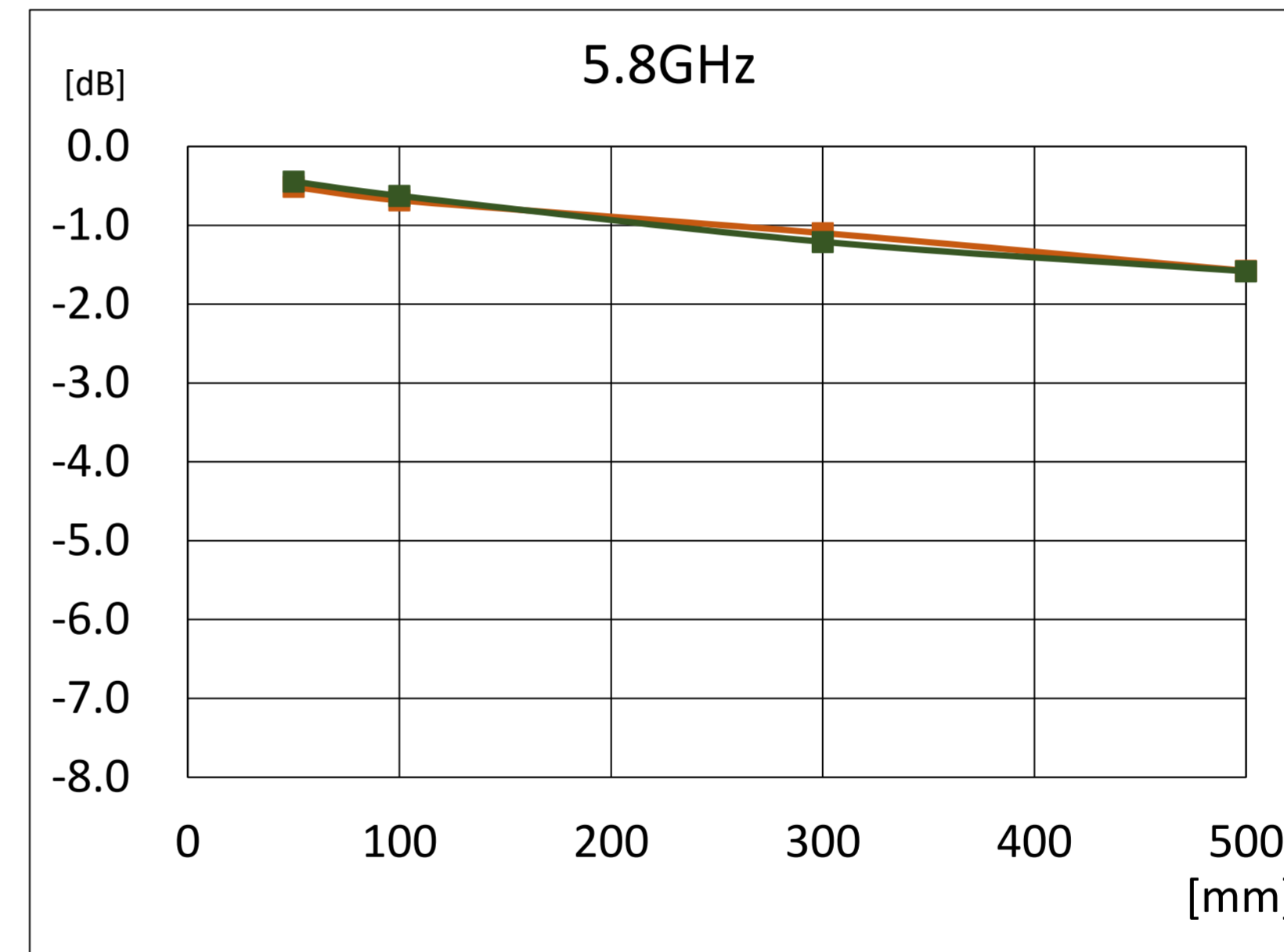
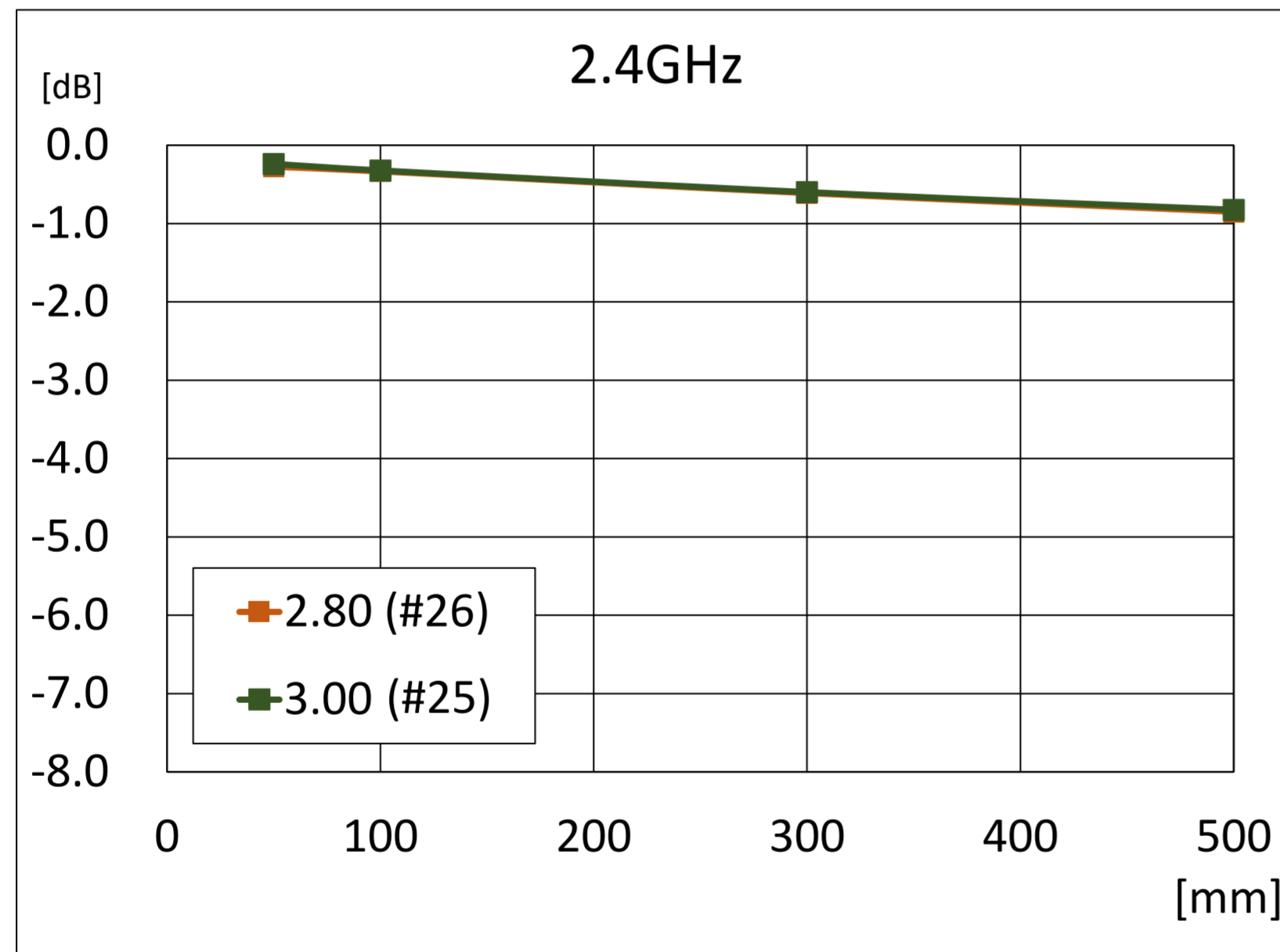

I-PEX Product Series



MHF[®]
Series
RF Connectors



EVAFLEX[®]
Series
MINIFLEX[®]
Series
FPC/FFC Connectors



AP
Series
Terminals



CABLINE[®]
Series
Micro-Coaxial/ Twinax
Connectors



ISH[®]
Series
IARPB[®]
Series
Wire-to-Board
Connectors



MINIDOCK[™]
Series
I/O Connectors



NOVASTACK[®]
Series
Board-to-Board
Connectors



Please [contact us](#) for custom products.



I-PEX, MHF, CABLINE, NOVASTACK, EVAFLEX, MINIFLEX, ISH, IARPB, IASLP, ESTORQ, i-Fit and ISFIT are registered trademarks of I-PEX Inc. Please note that the contents in the catalog might be changed without prior notification. I-PEX Inc. assumes no responsibility for any inaccuracies or obligation to update Information on these documents. Please be sure to read and understand the latest "Precautions for Use" and "Instruction Manual" before you use our products. We shall not be responsible for any defects, damages or troubles in case you use our products without following the precautions for use. Please feel free to contact our sales representatives when you use our products for any applications that require very high reliability and safety, or that relate to human life (ex. nuclear power control, aerospace, transportation, medical equipment, safety equipment etc.).

Contact your sales representative for more detailed information. [i-pex.com]

I-PEX Inc.