

CABLINE®-VS IIF

Part No.20862-0**T-01

Instruction Manual

2	S24468	November 19, 2024	T.Onishi	M.Muro	T.Masunaga
1	S21105	March 5, 2021	R.Fukuda	M.Muro	H.Ikari
0	S17844	November 14, 2017	Y.Miyazaki	T.Masunaga	H.Ikari
Rev.	ECN	Date	Prepared by	Checked by	Approved by

This manual is to explain the insertion and removal methods and important points in handling of CABLINE-VS IIF connectors for the purpose of proper use.

1. Product Names and Part Numbers

• Plug Connector

Product Name: CABLINE-VS IIF shell assembly

Part Number: 20862-0**T-01

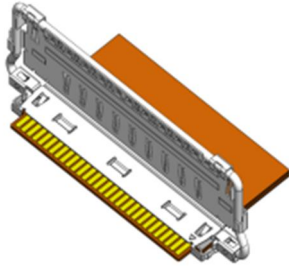

Fig. 2 Opened Shell Assembly with FPC

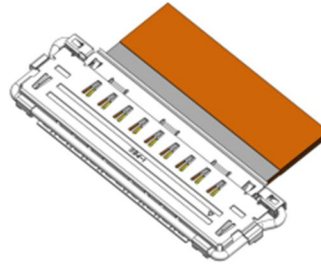

Fig. 1 Closed Shell Assembly with FPC

• Receptacle Connector

Product Name: CABLINE-VS II receptacle

Part Number: 20849-0**E-0#

1: With Boss

2: Without Boss

For detailed information on the variations indicated by "*" and "#", please refer to the drawing.

2. Names of the Connector Parts

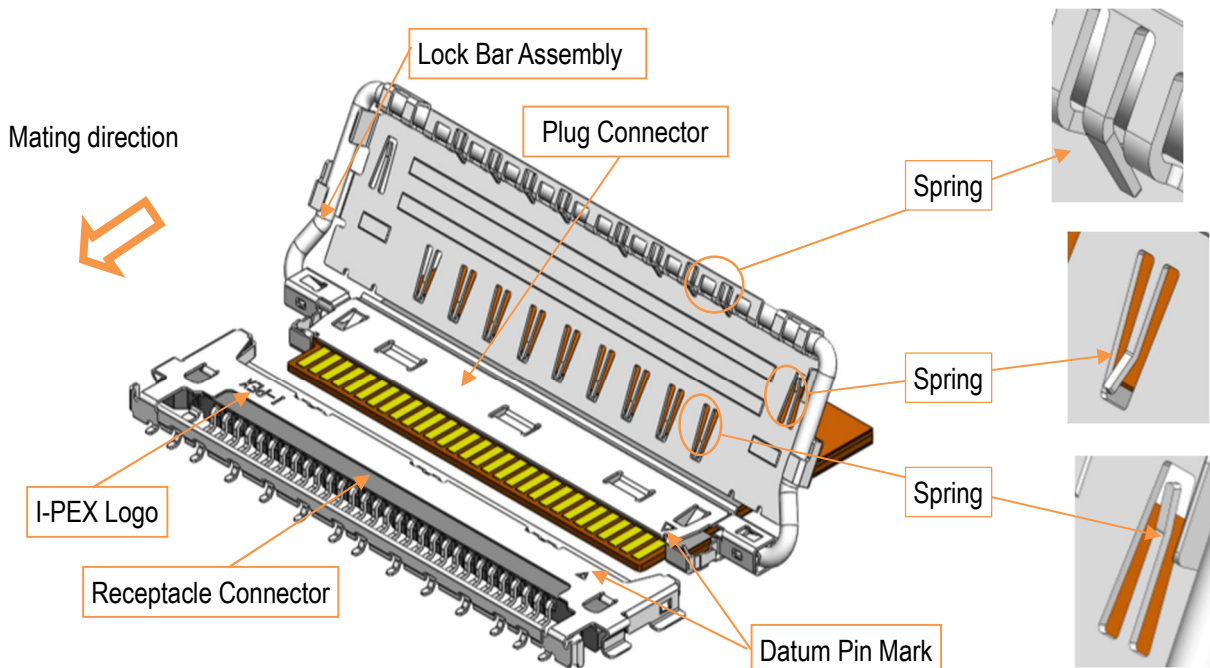

Fig. 3 Names of the Connector Parts

3. Connector Insertion Methods

3.1 Align the datum pin marks of the plug connector and the receptacle connector.

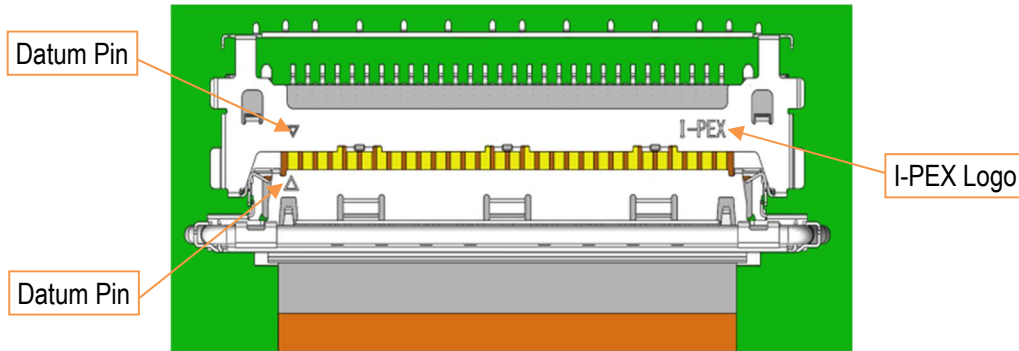

Fig. 4 Aligning Datum Pin Marks

3.2 Pre-insert the plug connector to the receptacle connector. Do not apply excessive load while pre-insertion.

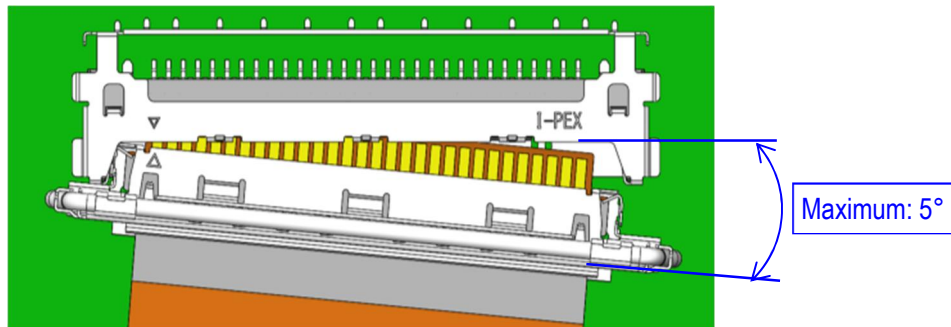

Fig. 5 Maximum Horizontal Insertion Angle

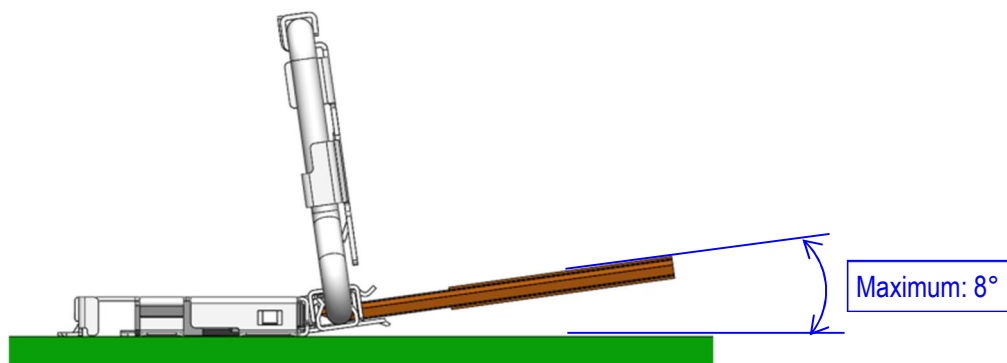

Fig. 6 Maximum Vertical Insertion Angle

3.3 Hold and push the FPC horizontally along the guide after the pre-insertion. Ensure that the gap is undetected after the insertion.

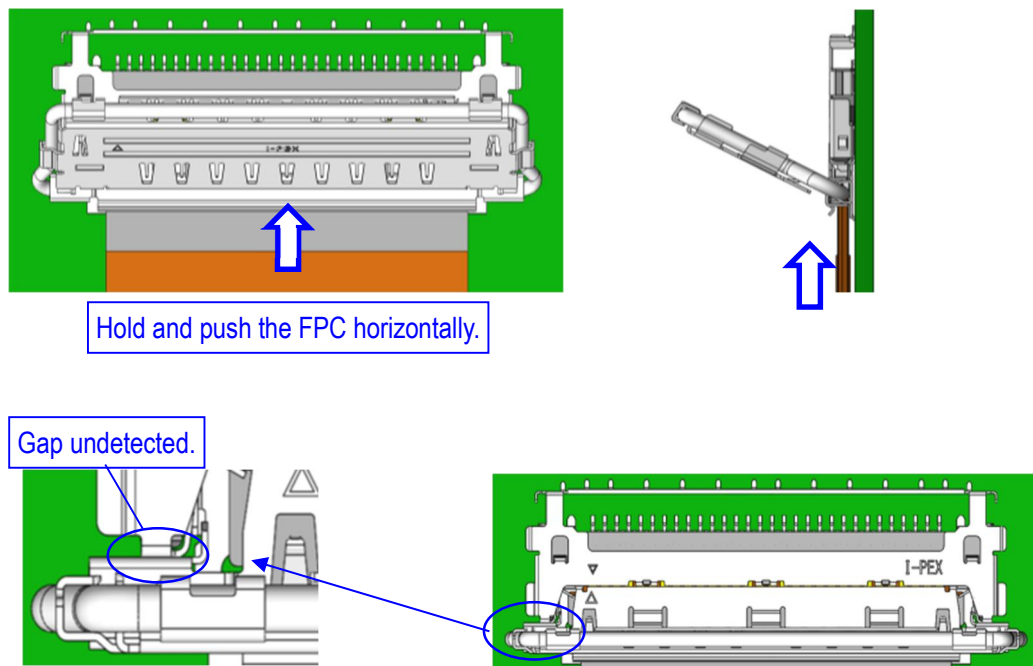

Fig. 7 Correct Insertion Method

Caution 1

Do not push one side of the plug connector alternately, as it may result in the incomplete insertion.

*Gap indicates incomplete insertion.

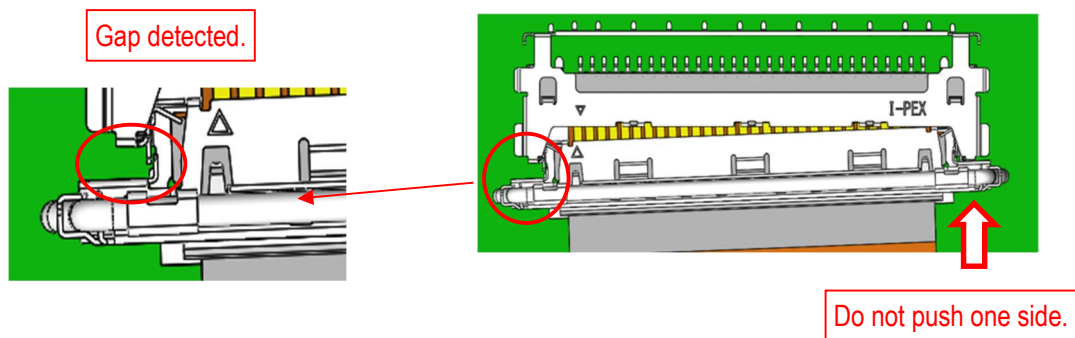

Fig. 8 Incorrect Insertion Check

Do not close the plug connector cover if a gap is detected, as it may cause interference and deformation.

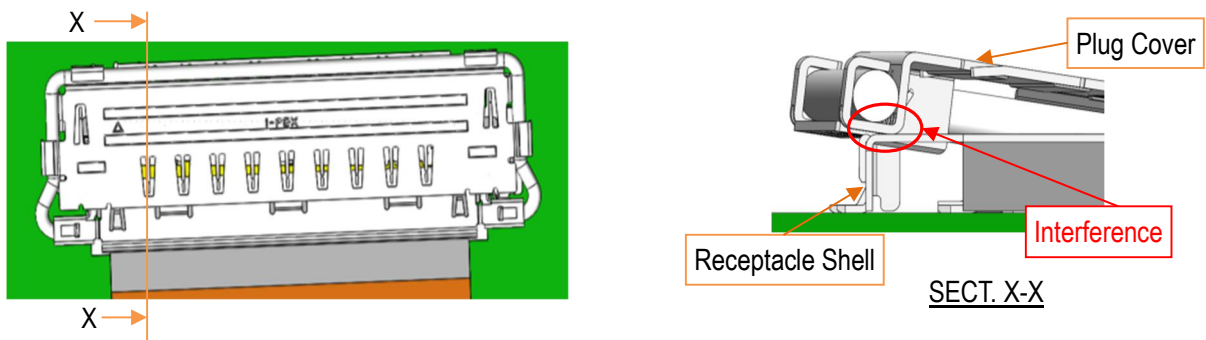

Fig. 9 Plug and Receptacle Interference

Caution 2

Ensure that the plug connector is inserted along the guide, as it may result in deformation.

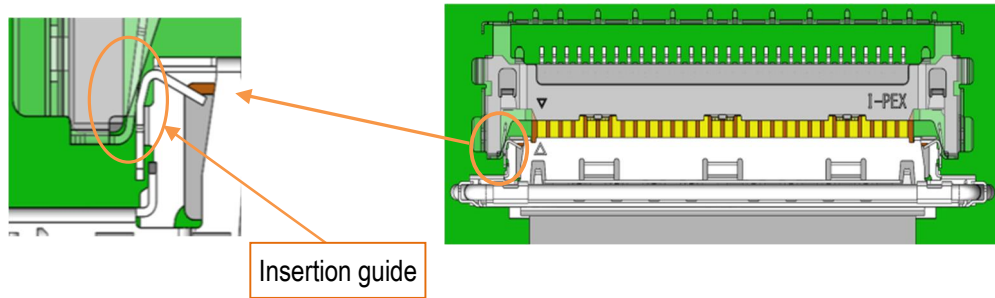

Fig. 10 Insertion Guide

Caution 3

Do not exceed 5° horizontal insertion angle during pre-insertion, as it may result in the damage or deformation.

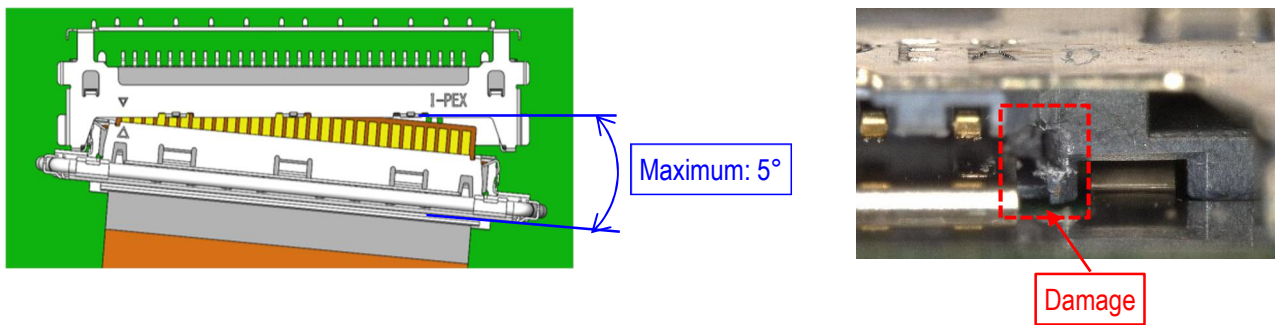

Fig. 11 Maximum Horizontal Insertion Angle

Caution 4

The lock bar assembly will stop upon contacting the FPC.
Do not push the lock bar assembly beyond the stop position, as it may result in FPC deformation.

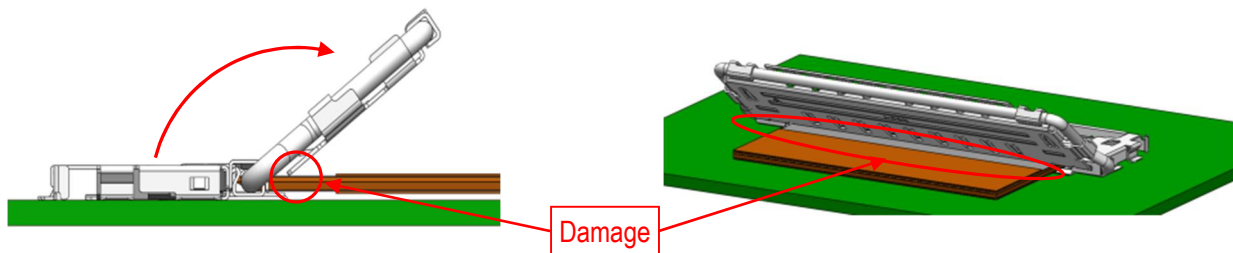

Fig. 12 The Lock Bar Opening Limitation

Caution 5

Do not exceed 8° vertical insertion angle during pre-insertion, as it may result in the damage or deformation.

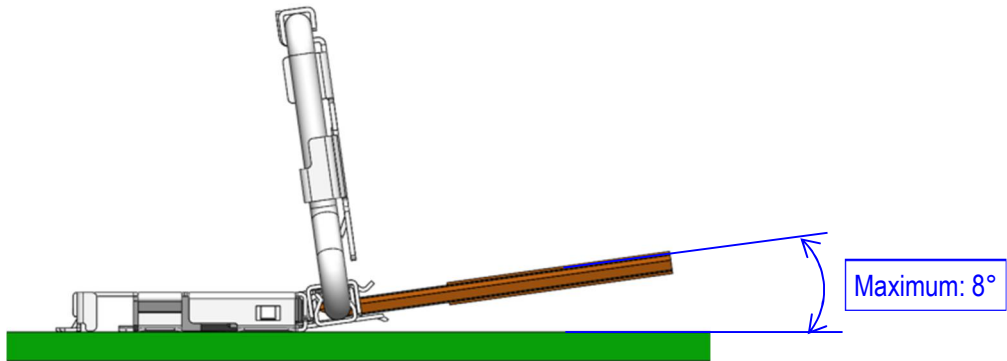

Fig. 13 Maximum Vertical Insertion Angle at Pre-insertion

Caution 6

Do not insert the plug connector by pushing or pulling the lock bar assembly, as it may result in connector damage and the lock bar assembly deformation.

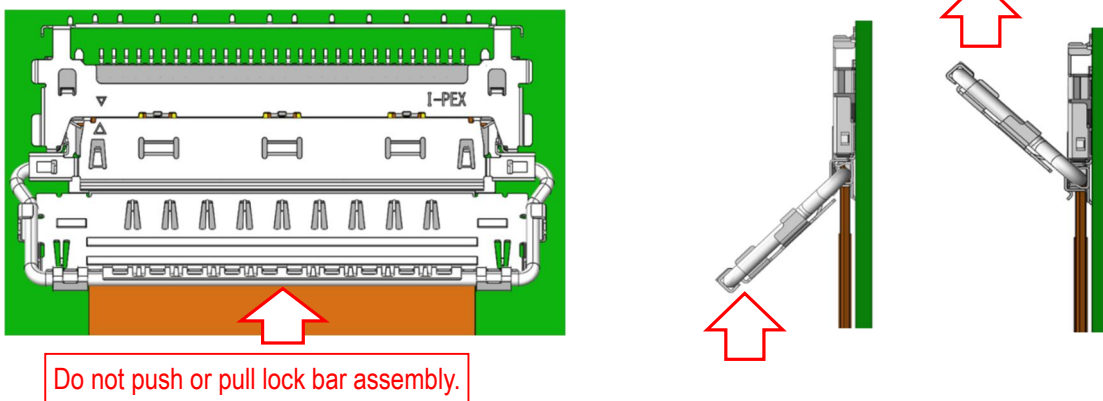

Fig. 14 Incorrect Insertion Method

Caution 7

Do not apply the force to the plug connector toward the PCB, as it may damage the PCB and result in the disconnection or short circuit.

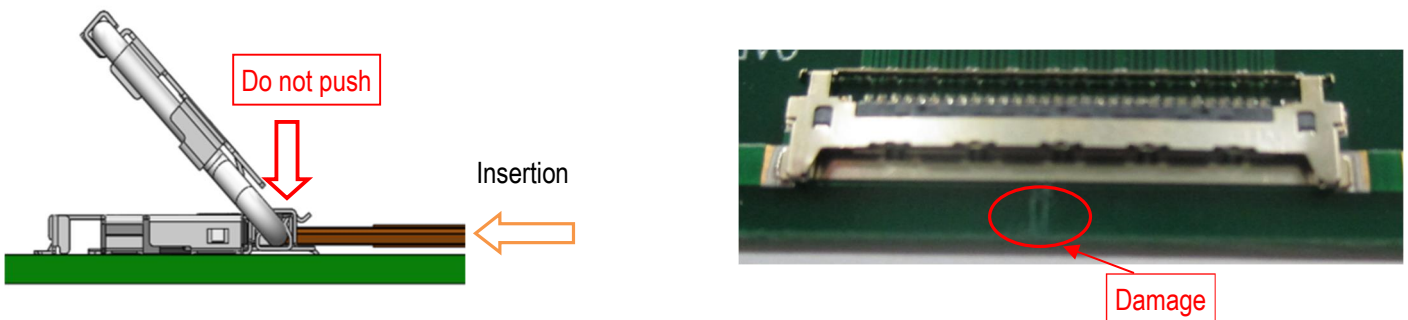

Fig. 15 Force Applying Prohibition

3.3 Push the circled areas of the lock bar assembly toward the PCB to lock the receptacle shell and the lock bar assembly.

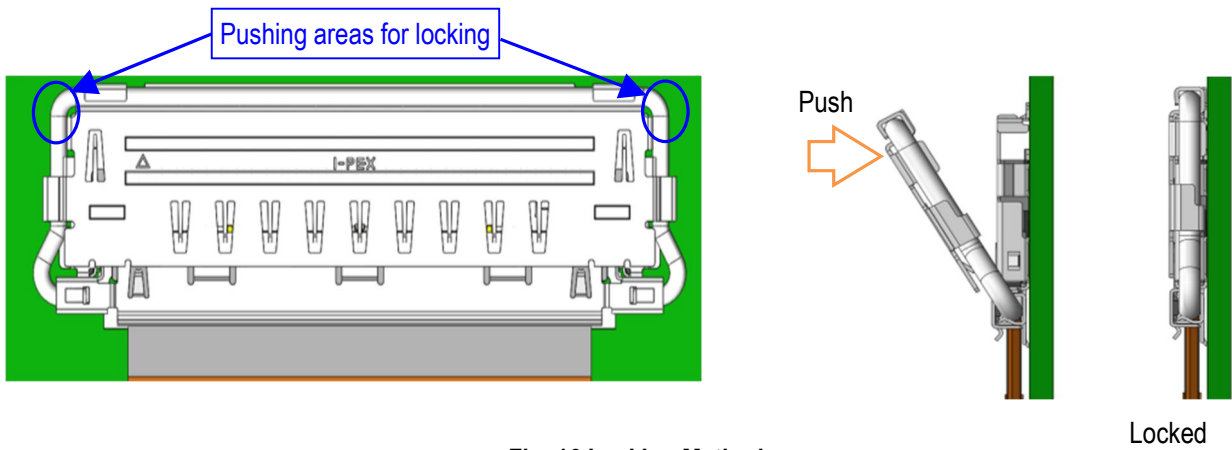

Fig. 16 Locking Method

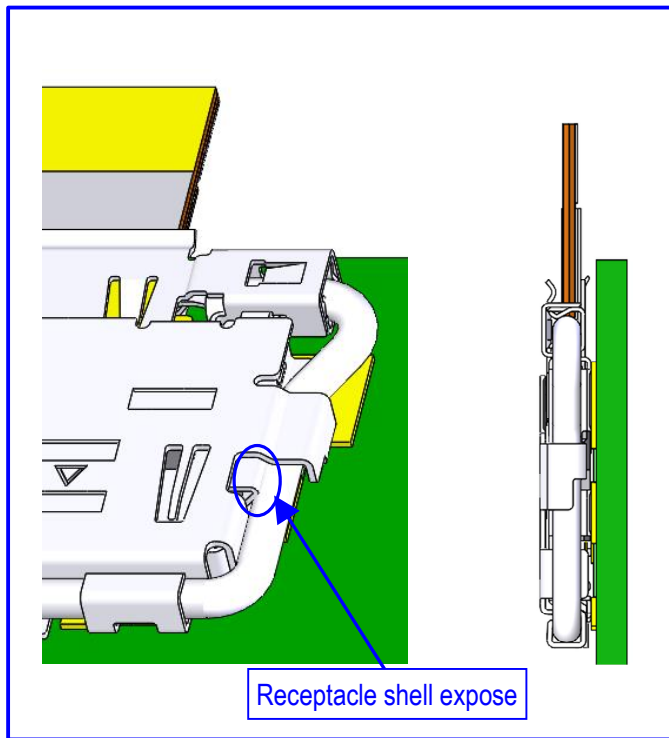

Fig. 17 Correctly Locked

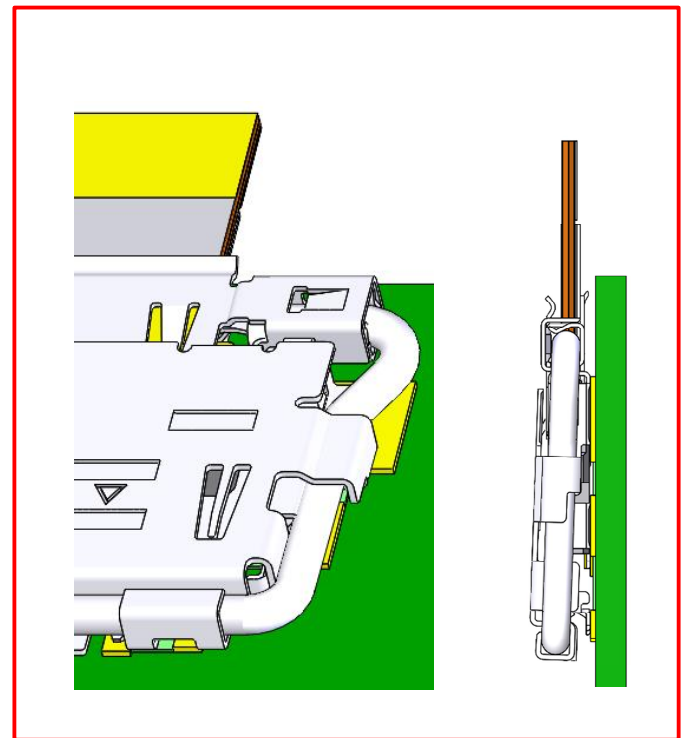

Fig. 18 Incorrectly Locked

4. Connector Removal Method

4.1 Lift up the circled area of the lock bar assembly and rotate it to release the lock from the receptacle connector.

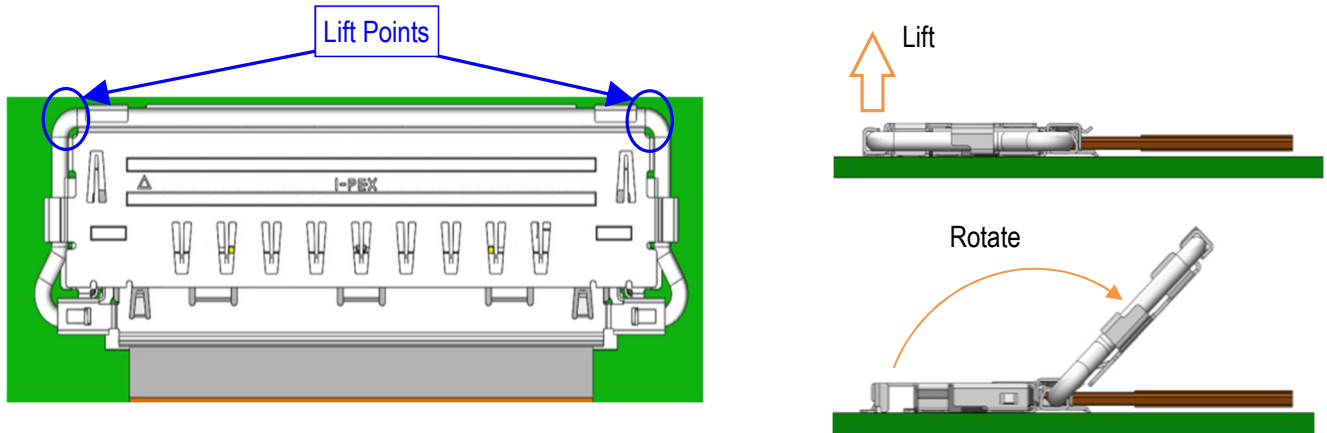

Fig. 19 Lock Release Method

Caution 8

Do not lift circled area of the lock bar assembly during removal, as it may result in the deformation.

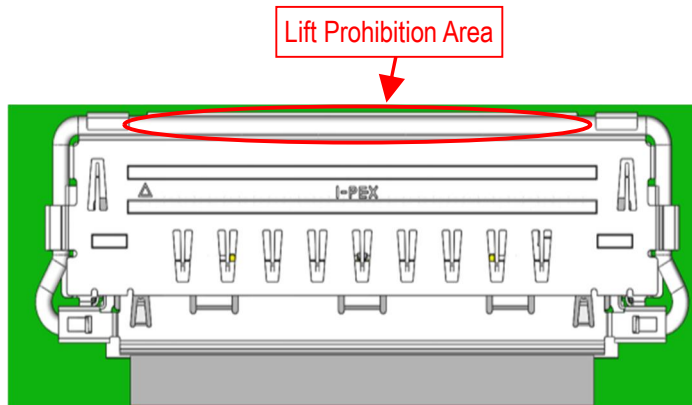

Fig. 20 Lift Prohibition Area

4.2 Hold and pull the FPC horizontally, keeping the ends parallel.

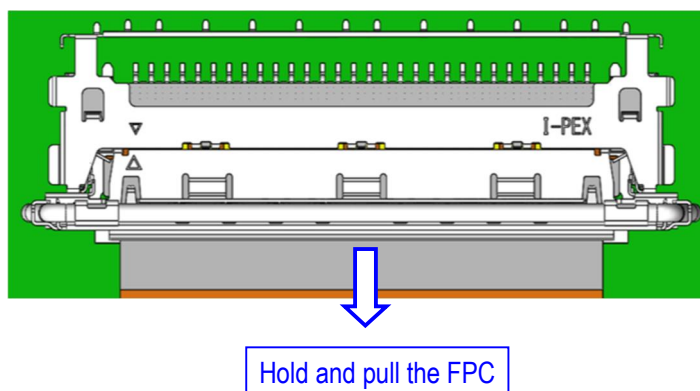

Fig. 21 Correct Removal Method

Caution 9

Do not exceed 5° horizontal removal angle during removal, as it may result in the damage or deformation.

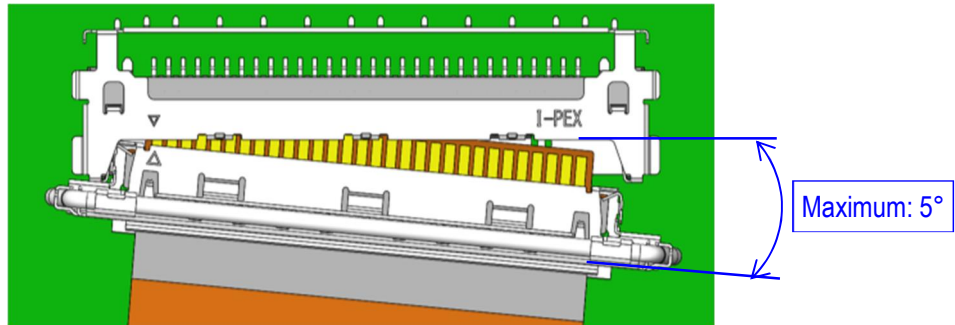

Fig. 22 Maximum Horizontal Removal Angle

Caution 10

Do not push or pull circled area of the lock bar assembly during removal, as it may result in the damage or deformation.

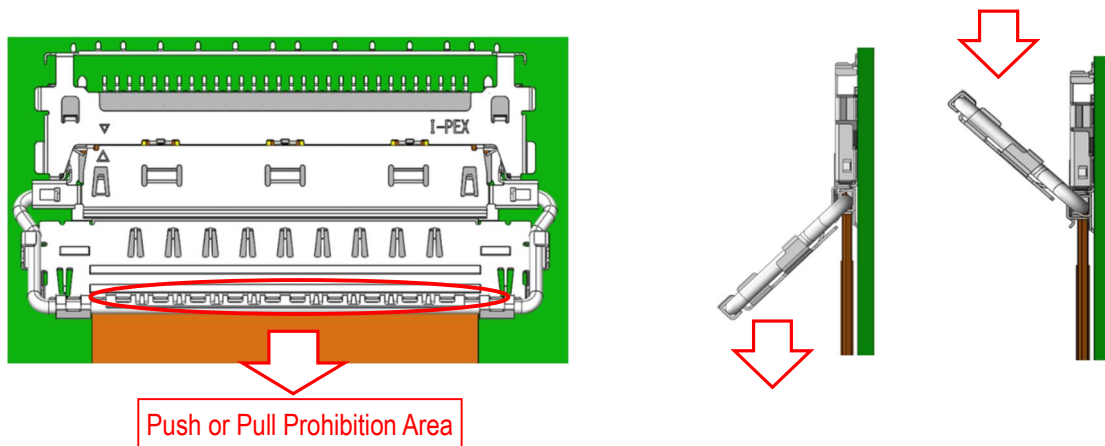

Fig. 23 Incorrect Removal Method

Caution 11

Do not apply the force to the plug connector toward the PCB during removal, as it may damage the PCB and result in the disconnection or short.

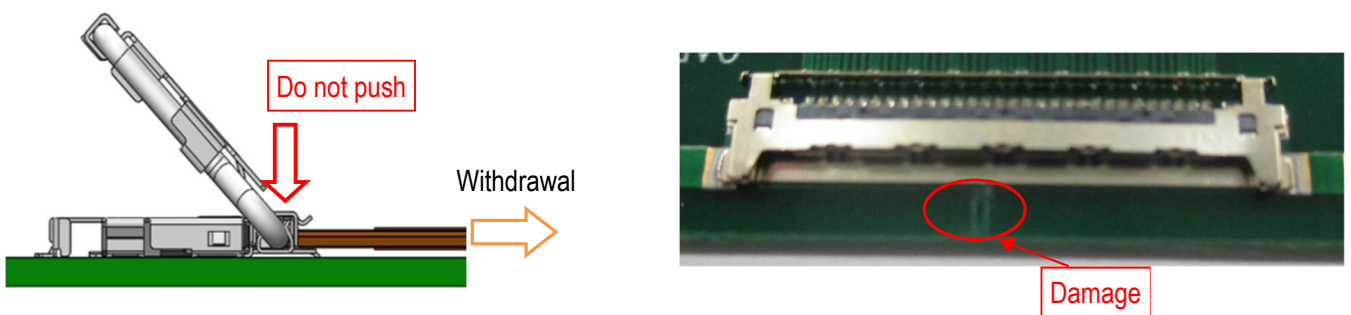

Fig. 24 Force Applying Prohibition

5. Cautions in handling the connector

5.1 Do not pull up the FPC or the lock bar assembly upward, as it may result in the deformation of the receptacle connector.

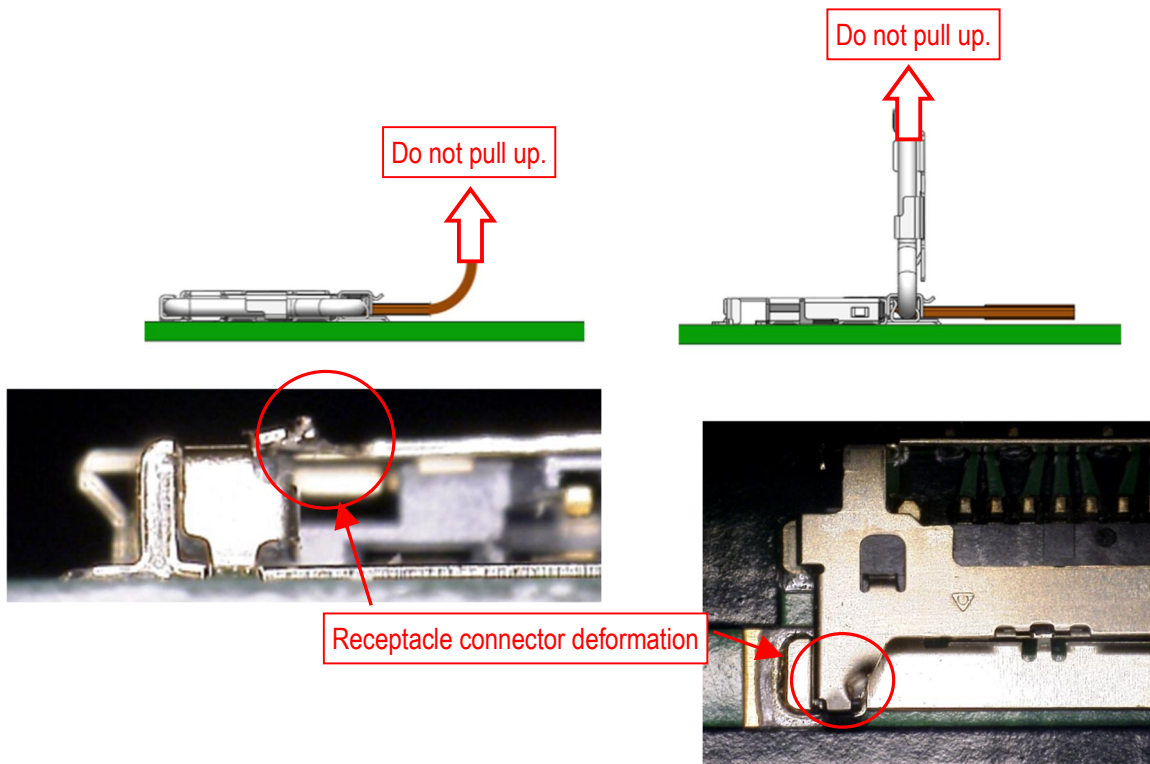

Fig. 25 Prohibition of FPC and Lock Bar Assembly Handling

5.2 Do not apply the continuous stress or excessive load to the connector, as it may result in the mating failure or the receptacle connector deformation.

When bending FPCs, ensure that stress or excessive load is not applied to the connectors.

Bending the FPC in the direction of arrows will cause stress or excessive load on the connector mating part.

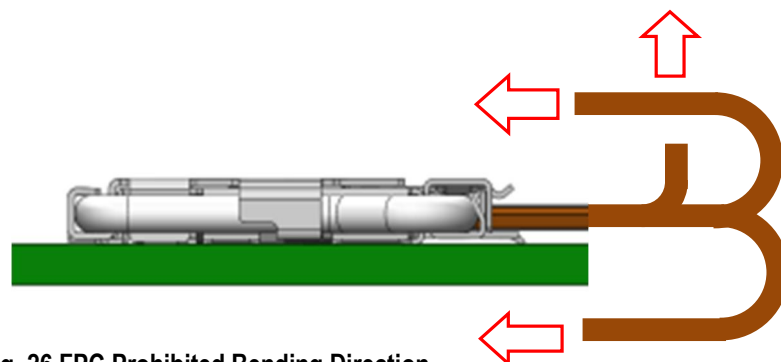

Fig. 26 FPC Prohibited Bending Direction