

PART NO.
8-23-0119

PLEASE CONTACT I-PEX FOR REQUESTS OTHER THAN THIS SPECIFICATIONS.
PLEASE NOTE IF SPECIFICATIONS CHANGE, PART NO. WILL ALSO CHANGE.

- NOTES
1. PACKING : PLASTIC BAG
 2. PERMISSIBLE LOAD ON THE CABLE AFTER MATING
 3. CABLE CRIMP STRENGTH : 15N MIN.
 4. ORIENTATION OF CONNECTORS : $0^\circ \pm 45^\circ$
 5. TO OPERATE LOCK PART
FOLLOW I-PEX INSTRUCTION MANUAL HIM-17020.
 6. DO NOT ROTATE THE PLUG IN THE MATING CONDITION.

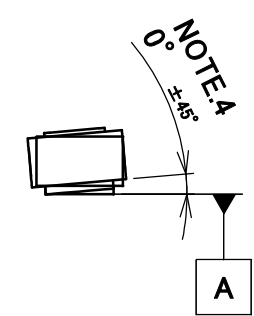
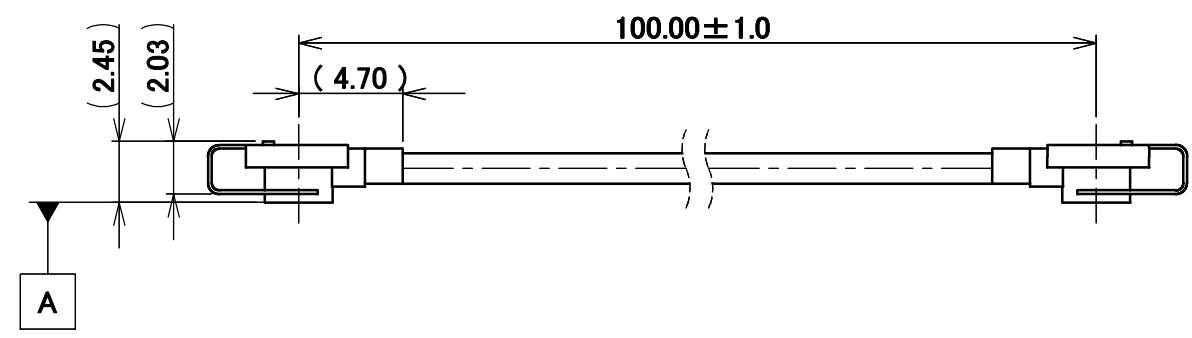
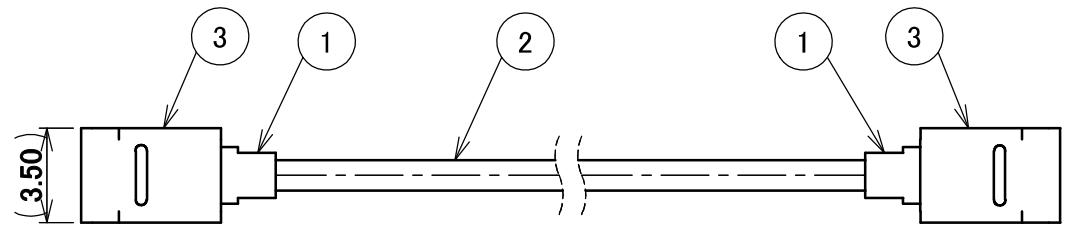
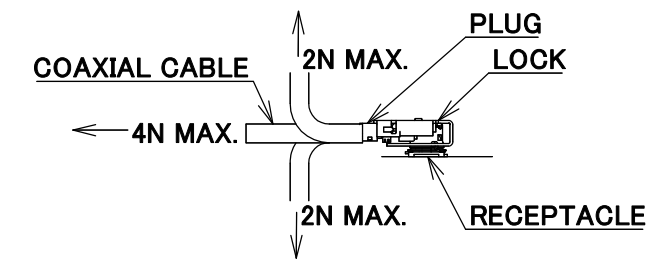

MULTIPLE CONNECTORS LAYOUT

COMPONENTS PLACEMENT PROHIBITED AREA
REQUIRED AREA FOR RECOMMENDED JIG TO OPERATE
MHF I LK HARNESS IN 4.50 ± 0.15 mm PITCH (M.2 PITCH) SMOOTHLY.
JIG PART NUMBER: 91492-0001

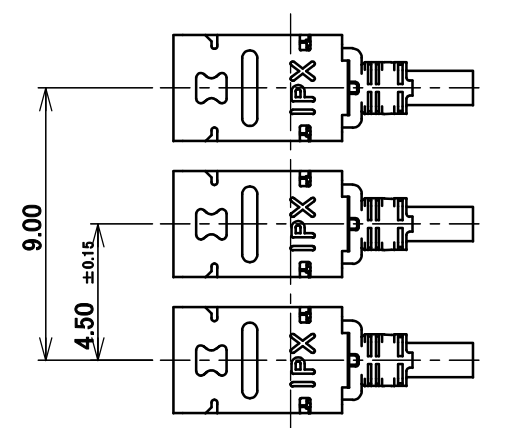
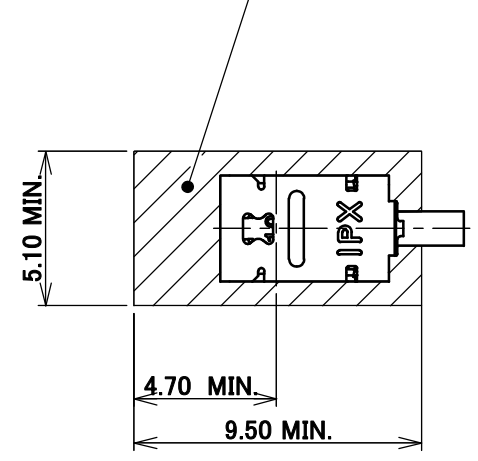

**MATING AND LOCK CONDITION
WITH MHF I LK HARNESS NARROW PITCH**

**MHF I LK HARNESS UNLOCK CONDITION
NARROW PITCH DIMENSIONS**

SINGLE CONNECTOR LAYOUT

COMPONENTS PLACEMENT PROHIBITED AREA
FOR PLUG 360° ROTATION AND UNMATING AND LOCK
JIG PART NUMBER: 91026-0001, 91492-0001

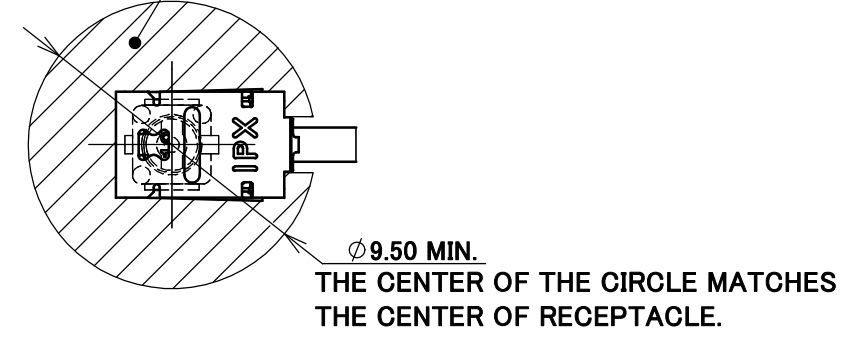

THE CENTER OF THE CIRCLE MATCHES
THE CENTER OF RECEPTACLE.

**MATING AND LOCK CONDITION
WITH MHF I LK HARNESS**

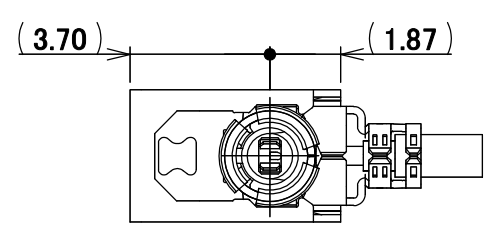

UNLOCKED CONDITION

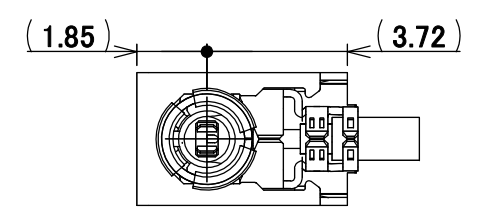

LOCKED CONDITION

DO NOT MATE WITH RECEPTACLE
UNDER THIS LOCKED CONDITION.

3	LOCK PART	2	-
2	CABLE	1	AWG#30 Φ 1.37, BRAIDED SHIELD , BLACK
1	CONNECTOR-1, 2	2	MHF I Au
NO.	DESCRIPTION	QTY	REMARK

REVISION RECORD					ANGLE $\pm 2^\circ$ 6 OVER 30 MAX. ± 0.3 6 MAX. ± 0.2 30 OVER 120 MAX. ± 0.5	PROJECTION 	SERIES No. H-230031P	CUSTOMER COPY	
0	Z231165	TOI	2023/09/27	APP.	GENERAL TOLERANCE. DWG. M.Toida DATE 2023/09/27 CHK. K.Yufu APP. Y.Hashimoto	TITLE MHF® I-I CABLE137-1 +LK	SCALE X:1 UNIT mm	I-PEX	
REV.	ECN	BY	DATE	APP.	DWG. No.	8-23-0119	SIZE	SHEET	REV.
							A3	1/1	0



Confidential C

I-PEX Inc.

QKE-DFE06-02 REV.12