

CABLINE[®]-UX II PLUG METAL COVER

Part No. 2799-#**1

Packing Standard

4	S20296	July 7, 2020	A.Koyanagi	T.Kurachi	Y.Shimada
3	S19199	March 26, 2019	A.Koyanagi	T.Masunaga	Y.Shimada
2	S14123	April 2, 2014	D.S	-	Tom
1	S12099	March 21, 2012	S.T	-	E.K
Rev.	ECN	Date	Prepared by	Checked by	Approved by

CABLINE-UX II PLUG METAL COVER Packing Standard

1. 製品名称/Product Name, 製品番号/Parts Number(s)

CABLINE-UXII PLUG METAL COVER, 2799-#**1







2. 梱包材料/Packing Material

芯数 POS.	リール径 DIAMETER	リール幅 REEL WIDTH	外装カートン PACKING CARTON
16P	φ380	44.0	406×406×214 OUTER
30P			
34P			
40P			
50P		49.0	

3. 梱包数量/Packing Quantity

芯数 POS.	入数/リール QTY. IN REEL	リール本数 REEL QTY.	入数/外装カートン QTY. IN PACKING CARTON
16P	20,000	3	60,000
30P			
34P			
40P			
50P			

4.現品票／Label

P/N	①	CHECK	⑧ 梱包卷盘  WPP 层间纸  WPP 
QTY	②	⑥	
LOT	③		
 ⑤ DAI-ICHI SEIKO CO., LTD.	NAME: ④ MADE IN ***** ← ⑦	REMARK  	

- ① Part Number
- ② Quantity
- ③ Ten Digits Product Lot Number

Y	Y	M	M	D	D	#	#	#	#
Year		Month		Day		Four Digit Code for I-PEX usage			

- ④ Product Name
- ⑤ QR Code
- ⑥ Check Stamp
- ⑦ Country of Origin
- ⑧ Recycle Mark and Compliance Mark

5.梱包方法/Packing Method

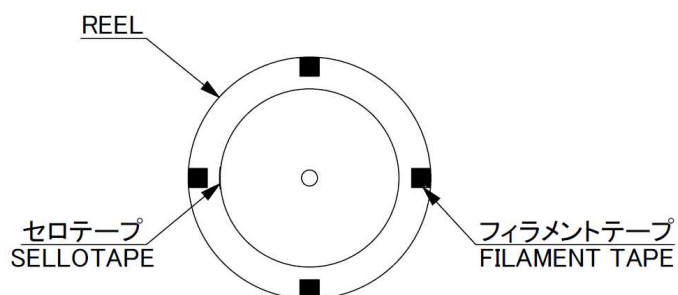

図 1 (Fig.1)

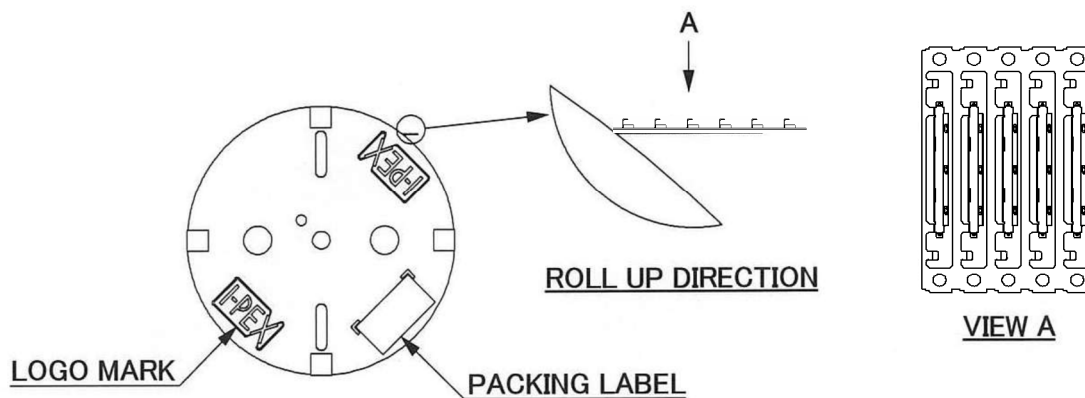
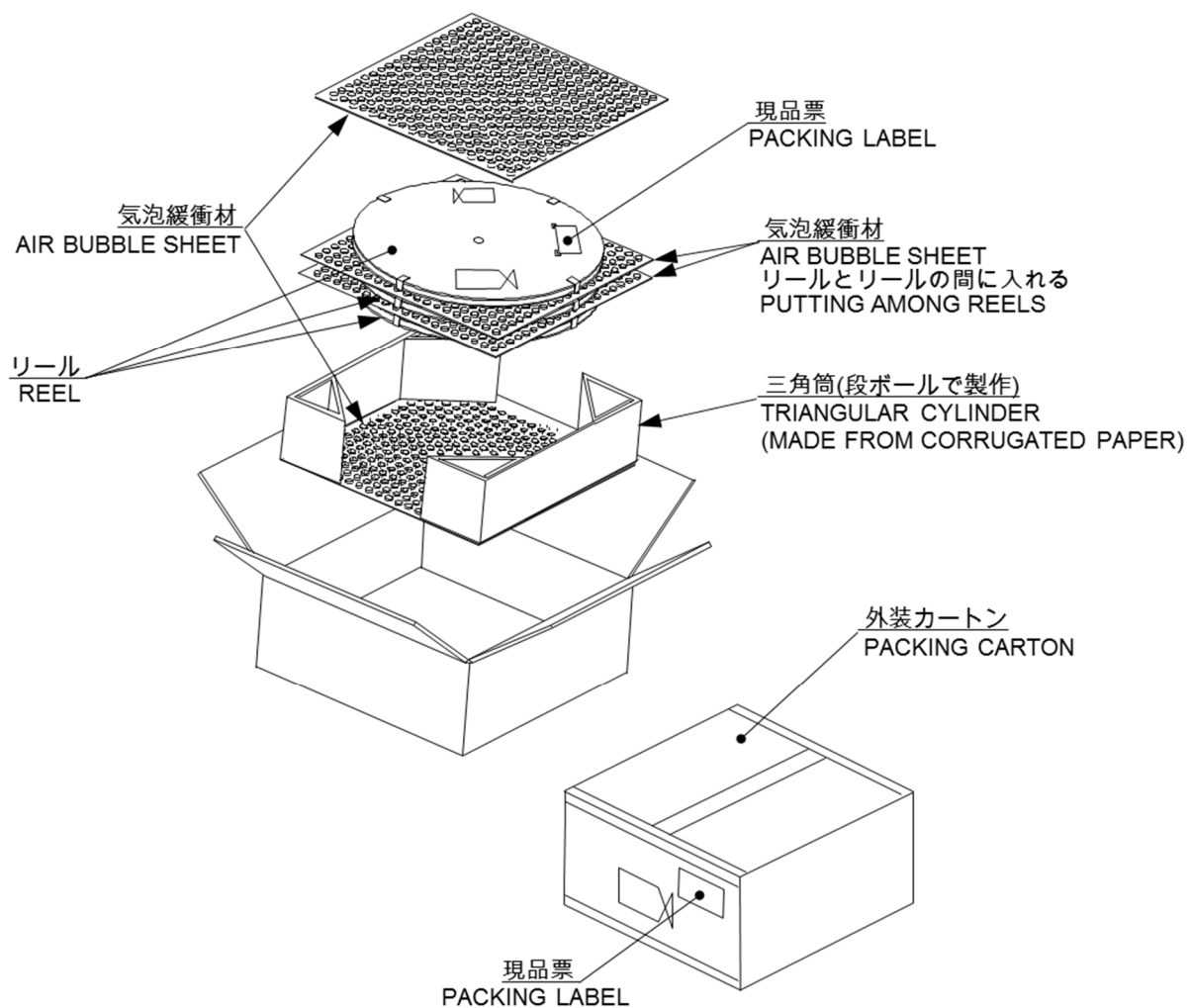

図 2 (Fig.2)